

1 Reference Manual

This manual is designed to be a reference manual for TR4W users. It is intended to be used in conjunction with the TR4W User Guide. The tables and sections covering basic aspects of TR4W are listed in the Table of Contents below.

1 Reference Manual	1
1.1 Supported Transceivers	9
1.2 Supported Contests	10
1.3 System Requirements	15
1.4 Files used by the Program	15
1.5 Program Installation	16
1.6 Program Windows -- Names and Colors	18
1.7 List of Hot Keys	18
1.7.1 Alt+ keys	18
1.7.2 Ctrl+ keys	19
1.7.3 Additional Ctrl + keys	20
1.7.4 Shift+Ctrl Keys	20
1.7.5 Ctrl+Alt+ Keys	20
1.7.6 Special Keys	21
1.8 Suggested Interface Circuits	21
1.8.1 CW Interface	21
1.9 TR Log Configuration Statements dropped from TR4W	27
1.10 Configuration Statements Added in TR4W	28
1.11 Configuration Statements List	29
1.12 Using Saved Configuration Statements.	29
1.13 Configuration Statement Table	30
1.14 Configuration Statement Definitions	36
1.14.1 ADD DOMESTIC COUNTRY	36
1.14.2 ALL CW MESSAGES CHAINABLE	36
1.14.3 ALLOW AUTO UPDATE	36
1.14.4 ALT-D BUFFER ENABLE	37
1.14.5 ALWAYS CALL BLIND CQ	37
1.14.6 ASK FOR FREQUENCIES	37
1.14.7 AUTO CALL TERMINATE	37
1.14.8 AUTO DISPLAY DUPE QSO	37
1.14.9 AUTO DUPE ENABLE CQ	37
1.14.10 AUTO DUPE ENABLE S AND P	38
1.14.11 AUTO QSL INTERVAL	38
1.14.12 AUTO QSO NUMBER DECREMENT	38

1.14.13	AUTO RETURN TO CQ MODE	38
1.14.14	AUTO S&P ENABLE	38
1.14.15	AUTO S&P ENABLE SENSITIVITY	38
1.14.16	AUTO SEND CHARACTER COUNT	38
1.14.17	AUTO TIME INCREMENT	39
1.14.18	AUTO-CQ DELAY TIME	39
1.14.19	BAND	39
1.14.20	BAND MAP ALL BANDS.....	39
1.14.21	BAND MAP ALL MODES.....	39
1.14.22	BAND MAP CALL WINDOW ENABLE.....	39
1.14.23	BAND MAP CUTOFF FREQUENCY	39
1.14.24	BAND MAP DECAY TIME.....	40
1.14.25	BAND MAP DISPLAY CQ.....	40
1.14.26	BAND MAP DUPE DISPLAY	40
1.14.27	BAND MAP ENABLE	40
1.14.28	BAND MAP GUARD BAND	40
1.14.29	BAND MAP MULTS ONLY	40
1.14.30	BAND MAP SPLIT MODE.....	40
1.14.31	BANDMAP ITEM HEIGHT	40
1.14.32	BANDMAP ITEM WIDTH.....	40
1.14.33	BEEP ENABLE	40
1.14.34	BEEP EVERY 10 QSOS.....	40
1.14.35	BOLD FONT.....	41
1.14.36	BROADCAST ALL PACKET DATA	41
1.14.37	CALL OK NOW CW MESSAGE	41
1.14.38	CALL OK NOW MESSAGE	41
1.14.39	CALL OK NOW SSB MESSAGE	41
1.14.40	CALL WINDOW SHOW ALL SPOTS	41
1.14.41	CALLSIGN UPDATE ENABLE	41
1.14.42	CATEGORY-ASSISTED.....	41
1.14.43	CATEGORY-BAND	41
1.14.44	CATEGORY-MODE	41
1.14.45	CATEGORY-OPERATOR	42
1.14.46	CATEGORY-POWER	42
1.14.47	CATEGORY-TRANSMITTER.....	42
1.14.48	CHECK LOG FILE SIZE	42
1.14.49	CLEAR DUPE SHEET	42
1.14.50	CODE SPEED	42
1.14.51	COLUMN DUPESHEET ENABLE	42
1.14.52	COMPLETE CALLSIGN MASK.....	42
1.14.53	COMPUTER ID	42
1.14.54	COMPUTER NAME.....	43
1.14.55	CONFIRM EDIT CHANGES	43
1.14.56	CONNECTION AT STARTUP.....	43
1.14.57	CONNECTION COMMAND.....	43
1.14.58	CONTACTS PER PAGE	43
1.14.59	CONTEST	43
1.14.60	CONTEST NAME	44

1.14.61	CONTEST TITLE	44
1.14.62	COUNT DOMESTIC COUNTRIES	44
1.14.63	COUNTRY INFORMATION FILE	44
1.14.64	CQ CW EXCHANGE NAME KNOWN	44
1.14.65	CQ CW EXCHANGE	44
1.14.66	CQ EXCHANGE NAME KNOWN.....	44
1.14.67	CQ EXCHANGE	44
1.14.68	CQ SSB EXCHANGE NAME KNOWN	44
1.14.69	CQ SSB EXCHANGE	44
1.14.70	CUSTOM CARET.....	44
1.14.71	CUSTOM INITIAL EXCHANGE STRING	45
1.14.72	CUSTOM USER STRING.....	45
1.14.73	CW ENABLE	45
1.14.74	CW SPEED FROM DATABASE.....	45
1.14.75	CW SPEED INCREMENT	45
1.14.76	CW TONE.....	45
1.14.77	DE ENABLE.....	45
1.14.78	DIGITAL MODE ENABLE.....	45
1.14.79	DISTANCE MODE	45
1.14.80	DIT DAH RATIO	46
1.14.81	DOMESTIC FILENAME.....	46
1.14.82	DOMESTIC MULTIPLIER.....	46
1.14.83	DUPE CHECK SOUND	46
1.14.84	DUPE SHEET AUTO RESET.....	46
1.14.85	DVP ENABLE	46
1.14.86	DVP PATH	46
1.14.87	DVP RECORDER	46
1.14.88	DX MULTIPLIER.....	46
1.14.89	ESCAPE EXITS SEARCH AND POUNCE	47
1.14.90	EXCHANGE MEMORY ENABLE.....	47
1.14.91	EXCHANGE RECEIVED	47
1.14.92	FARNSWORTH ENABLE.....	47
1.14.93	FARNSWORTH SPEED	47
1.14.94	FLOPPY FILE SAVE FREQUENCY	48
1.14.95	FLOPPY FILE SAVE NAME.....	48
1.14.96	FOOT SWITCH MODE	48
1.14.97	FOOT SWITCH PORT	48
1.14.98	FREQUENCY ADDER RADIO ONE	48
1.14.99	FREQUENCY ADDER RADIO TWO	48
1.14.100	FREQUENCY MEMORY	48
1.14.101	FREQUENCY MEMORY ENABLE	48
1.14.102	FREQUENCY POLL RATE.....	49
1.14.103	GRID MAP CENTER	49
1.14.104	HAND LOG MODE.....	49
1.14.105	HF BAND ENABLE	49
1.14.106	HOUR DISPLAY.....	49
1.14.107	INCLUDE F-KEY NUMBER.....	49
1.14.108	INCREMENT TIME ENABLE	49

1.14.109	INITIAL EXCHANGE	49
1.14.110	INITIAL EXCHANGE CURSOR POS.....	50
1.14.111	INITIAL EXCHANGE FILENAME.....	50
1.14.112	INITIAL EXCHANGE OVERWRITE.....	50
1.14.113	INSERT MODE.....	50
1.14.114	INTERCOM FILE ENABLE	50
1.14.115	KEYER RADIO ONE OUTPUT PORT	50
1.14.116	KEYER RADIO TWO OUTPUT PORT	50
1.14.117	KEYPAD CW MEMORIES	51
1.14.118	LATEST CONFIG FILE	51
1.14.119	LEADING ZERO CHARACTER	51
1.14.120	LEADING ZEROS.....	51
1.14.121	LEAVE CURSOR IN CALL WINDOW	51
1.14.122	LITERAL DOMESTIC QTH.....	51
1.14.123	LOG FREQUENCY ENABLE.....	51
1.14.124	LOG RS SENT.....	51
1.14.125	LOG RST SENT.....	52
1.14.126	LOG SUB TITLE	52
1.14.127	LOG WITH SINGLE ENTER	52
1.14.128	LOOK FOR RST SENT	52
1.14.129	LPT1 BASE ADDRESS.....	52
1.14.130	LPT2 BASE ADDRESS.....	52
1.14.131	LPT3 BASE ADDRESS.....	52
1.14.132	MAIN CALLSIGN.....	52
1.14.133	MAIN FONT	52
1.14.134	MESSAGE ENABLE	52
1.14.135	MINITOUR DURATION	53
1.14.136	MISSINGCALLSIGNS FILE ENABLE	53
1.14.137	MMTTY ENGINE	53
1.14.138	MP3 PATH	53
1.14.139	MP3 PLAYER	53
1.14.140	MP3 RECORDER BITRATE	53
1.14.141	MP3 RECORDER DURATION	53
1.14.142	MP3 RECORDER ENABLE	53
1.14.143	MULT BY BAND.....	53
1.14.144	MULT BY MODE.....	53
1.14.145	MULT REPORT MINIMUM BANDS.....	54
1.14.146	MULTI INFO MESSAGE	54
1.14.147	MULTI MULTS ONLY	54
1.14.148	MULTIPLE BANDS	54
1.14.149	MULTIPLE MODES	54
1.14.150	MY CALL	54
1.14.151	MY CHECK.....	54
1.14.152	MY CONTINENT	54
1.14.153	MY COUNTRY	55
1.14.154	MY FD CLASS	55
1.14.155	MY GRID	55
1.14.156	MY IOTA	55

1.14.157	MY NAME	55
1.14.158	MY POSTAL CODE	55
1.14.159	MY PREC	55
1.14.160	MY QTH	55
1.14.161	MY SECTION	56
1.14.162	MY STATE	56
1.14.163	MY ZONE	56
1.14.164	NAME FLAG ENABLE.....	56
1.14.165	NET STATUS UPDATE INTERVAL.....	56
1.14.166	NO BORDER.....	56
1.14.167	NO CAPTION.....	56
1.14.168	NO COLUMN HEADER	56
1.14.169	NO LOG.....	56
1.14.170	NO POLL DURING PTT	57
1.14.171	ORION PORT.....	57
1.14.172	PADDLE MONITOR TONE	57
1.14.173	PADDLE PORT	57
1.14.174	PADDLE PTT HOLD COUNT	57
1.14.175	PADDLE SPEED.....	57
1.14.176	PARTIAL CALL ENABLE.....	57
1.14.177	POLL RADIO ONE	57
1.14.178	POLL RADIO TWO	57
1.14.179	POSSIBLE CALL ACCEPT KEY.....	58
1.14.180	POSSIBLE CALL LEFT KEY.....	58
1.14.181	POSSIBLE CALL MODE	58
1.14.182	POSSIBLE CALL RIGHT KEY.....	58
1.14.183	POSSIBLE CALLS.....	58
1.14.184	PREFIX MULTIPLIER	58
1.14.185	PTT ENABLE	58
1.14.186	PTT LOCKOUT	58
1.14.187	PTT TURN ON DELAY	58
1.14.188	PTT VIA COMMANDS.....	59
1.14.189	QSL CW MESSAGE	59
1.14.190	QSL MESSAGE.....	59
1.14.191	QSL MODE	59
1.14.192	QSL SSB MESSAGE	59
1.14.193	QSO BEFORE CW MESSAGE.....	59
1.14.194	QSO BEFORE MESSAGE	59
1.14.195	QSO BEFORE SSB MESSAGE.....	59
1.14.196	QSO BY BAND	59
1.14.197	QSO BY MODE	59
1.14.198	QSO NUMBER BY BAND	59
1.14.199	QSO POINT METHOD.....	60
1.14.200	QSO POINTS DOMESTIC CW	60
1.14.201	QSO POINTS DOMESTIC PHONE.....	60
1.14.202	QSO POINTS DX CW.....	60
1.14.203	QSO POINTS DX PHONE.....	60
1.14.204	QSX ENABLE	60

1.14.205	QTC ENABLE	60
1.14.206	QTC EXTRA SPACE	61
1.14.207	QTC MINUTES.....	61
1.14.208	QTC QRS	61
1.14.209	QUESTION MARK CHAR.....	61
1.14.210	QUICK QSL CW MESSAGE	61
1.14.211	QUICK QSL CW MESSAGE1	61
1.14.212	QUICK QSL KEY 1	61
1.14.213	QUICK QSL KEY 2	61
1.14.214	QUICK QSL MESSAGE 1	61
1.14.215	QUICK QSL MESSAGE 2	61
1.14.216	QUICK QSL SSB MESSAGE.....	61
1.14.217	QZB RANDOM OFFSET ENABLE	62
1.14.218	R150S MODE	62
1.14.219	RADIO ONE BAND OUTPUT PORT	62
1.14.220	RADIO ONE BAUD RATE	62
1.14.221	RADIO ONE CAT DTR	62
1.14.222	RADIO ONE CAT RTS.....	62
1.14.223	RADIO ONE CONTROL PORT.....	62
1.14.224	RADIO ONE FREQUENCY ADDER	62
1.14.225	RADIO ONE FT1000MP CW REVERSE	62
1.14.226	RADIO ONE ICOM FILTER BYTE.....	62
1.14.227	RADIO ONE KEYER DTR.....	62
1.14.228	RADIO ONE KEYER RTS	62
1.14.229	RADIO ONE NAME	62
1.14.230	RADIO ONE RECEIVER ADDRESS.....	63
1.14.231	RADIO ONE TYPE	63
1.14.232	RADIO ONE WIDE CW FILTER	63
1.14.233	RADIO TWO BAND OUTPUT PORT	63
1.14.234	RADIO TWO BAUD RATE	63
1.14.235	RADIO TWO CAT DTR	63
1.14.236	RADIO TWO CAT RTS	63
1.14.237	RADIO TWO CONTROL PORT.....	63
1.14.238	RADIO TWO FREQUENCY ADDER	63
1.14.239	RADIO TWO FT1000MP CW REVERSE	63
1.14.240	RADIO TWO ICOM FILTER BYTE.....	63
1.14.241	RADIO TWO KEYER DTR.....	64
1.14.242	RADIO TWO KEYER RTS	64
1.14.243	RADIO TWO NAME	64
1.14.244	RADIO TWO RECEIVER ADDRESS.....	64
1.14.245	RADIO TWO TYPE	64
1.14.246	RADIO TWO WIDE CW FILTER	64
1.14.247	RADIUS OF EARTH	64
1.14.248	RANDOM CQ MODE	64
1.14.249	RATE DISPLAY	64
1.14.250	RELAY CONTROL PORT	65
1.14.251	REMAINING MULT DISPLAY MODE	65
1.14.252	REMINDER.....	65

1.14.253	REPEAT S& P CW EXCHANGE	65
1.14.254	REPEAT S&P EXCHANGE	65
1.14.255	REPEAT S&P SSB EXCHANGE	65
1.14.256	ROTATOR PORT	65
1.14.257	ROTATOR TYPE	65
1.14.258	ROW COUNT	65
1.14.259	S&P CW EXCHANGE.....	65
1.14.260	S&P EXCHANGE	65
1.14.261	S&P SSB EXCHANGE	65
1.14.262	SAY HI ENABLE.....	66
1.14.263	SAY HI RATE CUTOFF	66
1.14.264	SCORE POSTING URL	66
1.14.265	SCORE READING URL.....	66
1.14.266	SCP COUNTRY STRING	66
1.14.267	SCP MINIMUM LETTERS	66
1.14.268	SEND COMPLETE FOUR LETTER CALL	66
1.14.269	SERIAL PORT DEBUG	66
1.14.270	SERVER ADDRESS	66
1.14.271	SERVER PASSWORD.....	66
1.14.272	SERVER PORT.....	67
1.14.273	SHIFT KEY ENABLE	67
1.14.274	SHORT 0.....	67
1.14.275	SHORT 1.....	67
1.14.276	SHORT 2.....	67
1.14.277	SHORT 9.....	67
1.14.278	SHORT INTEGERS.....	67
1.14.279	SHOW DOMESTIC MULTIPLIER NAME.....	67
1.14.280	SHOW FREQUENCY IN LOG	67
1.14.281	SHOW GRIDLINES	67
1.14.282	SHOW TYPED CALLSIGN	67
1.14.283	SINGLE BAND SCORE	68
1.14.284	SINGLE RADIO MODE	68
1.14.285	SKIP ACTIVE BAND.....	68
1.14.286	SLASH MARK CHAR.....	68
1.14.287	SPACE BAR DUPE CHECK ENABLE.....	68
1.14.288	SPRINT QSY RULE	68
1.14.289	START SENDING NOW KEY	68
1.14.290	STATIONS CALLSIGNS MASK.....	68
1.14.291	STEREO CONTROL PIN	69
1.14.292	STEREO CONTROL PORT	69
1.14.293	STEREO PIN HIGH	69
1.14.294	SWAP PACKET SPOT RADIOS	69
1.14.295	SWAP PADDLES	69
1.14.296	SWAP RADIO RELAY SENSE	69
1.14.297	TAIL END CW MESSAGE.....	69
1.14.298	TAIL END KEY	69
1.14.299	TAIL END MESSAGE	69
1.14.300	TAIL END SSB MESSAGE	69

1.14.301	TELNET SERVER	69
1.14.302	TEN MINUTE RULE.....	69
1.14.303	TUNE ALT-D ENABLE.....	70
1.14.304	TUNE WITH DITS.....	70
1.14.305	TWO RADIO MODE.....	70
1.14.306	UNKNOWN COUNTRY FILE ENABLE	70
1.14.307	UNKNOWN COUNTRY FILE NAME	70
1.14.308	USE CONTROL PORT	70
1.14.309	USE RECORDED SIGNS.....	70
1.14.310	USER INFO SHOWN	70
1.14.311	VHF BAND ENABLE	70
1.14.312	WAIT FOR STRENGTH	71
1.14.313	WAKE UP TIME OUT.....	71
1.14.314	WARC BAND ENABLE.....	71
1.14.315	WEIGHT	71
1.14.316	WILDCARD PARTIALS.....	71
1.14.317	WK AUTOSPACE	71
1.14.318	WK CT SPACING.....	71
1.14.319	WK DIT DAH RATIO.....	71
1.14.320	WK ENABLE	72
1.14.321	WK FIRST EXTENSION	72
1.14.322	WK IGNORE SPEED POT.....	72
1.14.323	WK KEYER COMPENSATION	72
1.14.324	WK KEYER MODE.....	72
1.14.325	WK LEADIN TIME	72
1.14.326	WK PADDLE ONLY SIDETONE	72
1.14.327	WK PADDLE SWAP.....	73
1.14.328	WK PADDLE SWITCHPOINT	73
1.14.329	WK PORT	73
1.14.330	WK SIDETONE FREQUENCY	73
1.14.331	WK SIDETONE ENABLE	73
1.14.332	WK TAIL TIME	73
1.14.333	WK WEIGHT.....	73
1.14.334	WINDOW SIZE	73
1.14.335	ZONE MULTIPLIER	74

1.1 Supported Transceivers

#	Transceiver	Polling	PTT VIA COMMANDS	Baud Rate	Radio Address
1	K2	OK	OK	4800	-
2	K3	OK	OK	4800	-
3	TS850	OK	OK	4800	-
4	FT100	OK	OK	4800	-
5	FT450	OK	OK	4800	-
6	FT736R	-	-	4800	-
7	FT747GX	OK	OK	4800	-
8	FT767	OK	-	4800	-
9	FT817	OK	OK	4800	-
10	FT840	OK	OK	4800	-
11	FT847	OK	OK	4800	-
12	FT857	OK	-	4800	-
13	FT890	OK	OK	4800	-
14	FT897	OK	-	4800	-
15	FT900	OK	OK	4800	-
16	FT920	OK	-	4800	-
17	FT950	OK	OK	4800	-
18	FT990	OK	OK	4800	-
19	FT1000	OK	OK	4800	-
20	FT1000MP	OK	OK	4800	-
21	FT2000	OK	OK	4800	-
22	FTDX9000	OK	OK	4800	-
23	IC706	OK	-	1200	48
24	IC706II	OK	-	1200	4E
25	IC706IIG	OK	-	1200	58
26	IC707	OK	-	1200	3E
27	IC718	OK	-	1200	5E
28	IC725	OK	-	1200	28
29	IC726	OK	-	1200	30
30	IC728	OK	-	1200	38
31	IC729	OK	-	1200	3A
32	IC735	OK	-	1200	04
33	IC736	OK	-	1200	40
34	IC737	OK	-	1200	3C
35	IC738	OK	-	1200	44
36	IC746	OK	-	1200	56
37	IC746PRO	OK	-	1200	66
38	IC756	OK	-	1200	50
39	IC756PRO	OK	-	9600	5C
40	IC756PROII	OK	-	9600	64
41	IC756PROIII	OK	-	9600	6E

#	Transceiver	Polling	PTT VIA COMMANDS	Baud Rate	Radio Address
42	IC761	OK	-	9600	1E
43	IC765	OK	-	9600	2C
44	IC775	OK	-	19 200	46
45	IC781	OK	-	9600	26
46	IC910H	OK	-	9600	60
47	IC970D	OK	-	9600	2E
48	IC7000	OK	-	9600	70
49	IC7600	OK	-	9600	7A
50	IC7700	OK	-	19 200	74
51	IC7800	OK	-	9600	6A
52	OMNI6	OK	-	9600	04
53	ORION	-	OK	57 600	-

1.2 Supported Contests

#	CONTEST	QSO BY BAND	QSO BY MODE	MULT BY BAND	MULT BY MODE	EXCHANGE RECEIVED
1	7QP	TRUE	TRUE	FALSE	FALSE	RST DOMESTIC OR DX QTH
2	ALL JA	TRUE	FALSE	TRUE	FALSE	RST ALL JA PREFECTURE AND PRECEDENCE
3	ALL-ASIAN-DX- CW	TRUE	FALSE	TRUE	FALSE	RST AGE
4	ALL-ASIAN-DX- SSB	TRUE	FALSE	TRUE	FALSE	RST AGE
5	ALRS-UA1DZ- CUP	TRUE	TRUE	TRUE	FALSE	RST QSO NUMBER OR DOMESTIC QTH
6	AP-SPRINT	TRUE	FALSE	FALSE	FALSE	RST QSO NUMBER
7	ARCI	TRUE	FALSE	TRUE	FALSE	RST POSSIBLE DOMESTIC QTH AND POWER
8	ARI	TRUE	TRUE	TRUE	FALSE	RST QSO NUMBER OR DOMESTIC QTH
9	ARKTIKA-SPRING	TRUE	TRUE	TRUE	FALSE	RST QSO NUMBER OR DOMESTIC QTH
10	ARRL-10	FALSE	TRUE	FALSE	TRUE	RST DOMESTIC QTH OR QSO NUMBER
11	ARRL-160	FALSE	FALSE	FALSE	FALSE	RST DOMESTIC OR DX QTH
12	ARRL-DX-CW	TRUE	FALSE	TRUE	FALSE	RST POWER
13	ARRL-DX-SSB	TRUE	FALSE	TRUE	FALSE	RST POWER
14	ARRL-FD	TRUE	TRUE	FALSE	FALSE	CLASS DOMESTIC OR DX QTH

#	CONTEST	QSO BY BAND	QSO BY MODE	MULT BY BAND	MULT BY MODE	EXCHANGE RECEIVED
15	ARRL-SS-CW	FALSE	FALSE	FALSE	FALSE	QSO NUMBER PRECEDENCE CHECK SECTION
16	ARRL-SS-SSB	FALSE	FALSE	FALSE	FALSE	QSO NUMBER PRECEDENCE CHECK SECTION
17	ARRL-VHF-QSO	TRUE	FALSE	TRUE	FALSE	RST DOMESTIC QTH
18	ARRL-VHF-SS	TRUE	FALSE	TRUE	FALSE	RST DOMESTIC QTH
19	AS-CHAMP-CW	TRUE	FALSE	FALSE	FALSE	QSO NUMBER AND COORDINATES SUM
20	AS-CHAMP-SSB	TRUE	FALSE	FALSE	FALSE	QSO NUMBER AND COORDINATES SUM
21	BALTIC	FALSE	TRUE	FALSE	FALSE	RST QSO NUMBER
22	BLACK SEA CUP	TRUE	TRUE	TRUE	FALSE	RST ZONE OR SOCIETY
23	CALIFORNIA QSO PARTY	TRUE	TRUE	FALSE	FALSE	QSO NUMBER DOMESTIC OR DX QTH
24	CIS	TRUE	FALSE	TRUE	FALSE	RST DOMESTIC QTH OR QSO NUMBER
25	COLORADO QSO PARTY	TRUE	TRUE	FALSE	TRUE	NAME DOMESTIC OR DX QTH
26	COUNTY HUNTER	FALSE	FALSE	FALSE	FALSE	RST QTH
27	CQ-160-CW	FALSE	FALSE	FALSE	FALSE	RST ZONE OR DOMESTIC QTH
28	CQ-160-SSB	FALSE	FALSE	FALSE	FALSE	RST ZONE OR DOMESTIC QTH
29	CQ-M	TRUE	TRUE	TRUE	FALSE	RST QSO NUMBER
30	CQ-VHF	TRUE	FALSE	TRUE	FALSE	RST DOMESTIC QTH
31	CQ-WPX-CW	TRUE	FALSE	FALSE	FALSE	RST QSO NUMBER
32	CQ-WPX-SSB	TRUE	FALSE	FALSE	FALSE	RST QSO NUMBER
33	CQ-WW-CW	TRUE	FALSE	TRUE	FALSE	RST ZONE
34	CQ-WW-SSB	TRUE	FALSE	TRUE	FALSE	RST ZONE
35	CROATIAN	TRUE	FALSE	TRUE	FALSE	RST QSO NUMBER
36	DARC-10M	FALSE	TRUE	FALSE	FALSE	RST QSO NUMBER OR DOMESTIC QTH
37	DARC-WAEDC-CW	TRUE	FALSE	TRUE	FALSE	RST QSO NUMBER
38	DARC-WAEDC-SSB	TRUE	FALSE	TRUE	FALSE	RST QSO NUMBER
39	DARC-XMAS	TRUE	TRUE	TRUE	FALSE	RST QSO NUMBER OR DOMESTIC QTH
40	EU SPRINT	TRUE	FALSE	FALSE	FALSE	QSO NUMBER AND NAME
41	EUROPEAN HFC	TRUE	TRUE	TRUE	FALSE	RST ZONE
42	EUROPEAN VHF	TRUE	FALSE	TRUE	FALSE	RST QSO NUMBER AND GRID SQUARE
43	FCG-FQP	TRUE	TRUE	FALSE	TRUE	RST DOMESTIC OR DX QTH

#	CONTEST	QSO BY BAND	QSO BY MODE	MULT BY BAND	MULT BY MODE	EXCHANGE RECEIVED
44	FISTS	TRUE	FALSE	FALSE	FALSE	RST QTH NAME AND FISTS NUMBER OR POWER
45	GACW-WWSA-CW	TRUE	FALSE	TRUE	FALSE	RST ZONE
46	GAGARIN-CUP	TRUE	FALSE	TRUE	FALSE	RST ZONE
47	GENERAL QSO	TRUE	TRUE	FALSE	FALSE	RST NAME QTH
48	GRID LOC	TRUE	TRUE	TRUE	FALSE	NAME AND POSSIBLE GRID SQUARE
49	HA DX	TRUE	TRUE	TRUE	FALSE	RST DOMESTIC QTH OR QSO NUMBER
50	HELVETIA	TRUE	FALSE	TRUE	FALSE	RST QSO NUMBER AND POSSIBLE DOMESTIC QTH
51	IARU-HF	TRUE	TRUE	TRUE	FALSE	RST ZONE OR SOCIETY
52	INTERNET SPRINT	TRUE	FALSE	FALSE	FALSE	QSO NUMBER NAME DOMESTIC OR DX QTH
53	JA LONG PREFECT	FALSE	TRUE	FALSE	FALSE	RST LONG JA PREFECTURE
54	JIDX-CW	TRUE	FALSE	TRUE	FALSE	RST ZONE
55	JIDX-SSB	TRUE	FALSE	TRUE	FALSE	RST ZONE
56	KCJ	TRUE	FALSE	TRUE	FALSE	RST DOMESTIC QTH
57	KIDS DAY	FALSE	FALSE	FALSE	FALSE	KIDS DAY EXCHANGE
58	KING-OF-SPAIN-CW	TRUE	FALSE	TRUE	FALSE	RST DOMESTIC QTH OR QSO NUMBER
59	KING-OF-SPAIN-SSB	TRUE	FALSE	TRUE	FALSE	RST DOMESTIC QTH OR QSO NUMBER
60	KVP	FALSE	TRUE	TRUE	TRUE	RST ZONE
61	LQP	TRUE	FALSE	FALSE	FALSE	QSO NUMBER NAME DOMESTIC OR DX QTH
62	LZ DX	TRUE	TRUE	TRUE	FALSE	RST ZONE OR DOMESTIC QTH
63	MICHIGAN QSO PARTY	TRUE	TRUE	FALSE	TRUE	QSO NUMBER DOMESTIC QTH
64	MINITEST	FALSE	FALSE	FALSE	FALSE	RST QSO NUMBER
65	MINNESOTA QSO PARTY	TRUE	TRUE	FALSE	FALSE	NAME DOMESTIC OR DX QTH
66	MONGOLIAN DX	TRUE	TRUE	TRUE	FALSE	RST ZONE
67	NAQP-CW	TRUE	FALSE	TRUE	FALSE	NAME DOMESTIC OR DX QTH
68	NAQP-SSB	TRUE	FALSE	TRUE	FALSE	NAME DOMESTIC OR DX QTH
69	NA-SPRINT-CW	TRUE	FALSE	FALSE	FALSE	QSO NUMBER NAME DOMESTIC OR DX QTH
70	NA-SPRINT-SSB	TRUE	FALSE	FALSE	FALSE	QSO NUMBER NAME DOMESTIC OR DX QTH
71	NCCC-SPRINT	TRUE	FALSE	TRUE	FALSE	QSO NUMBER NAME DOMESTIC OR DX QTH

#	CONTEST	QSO BY BAND	QSO BY MODE	MULT BY BAND	MULT BY MODE	EXCHANGE RECEIVED
72	NEQP	TRUE	TRUE	FALSE	FALSE	RST DOMESTIC OR DX QTH
73	NEW YORK QSO PARTY	TRUE	TRUE	FALSE	FALSE	RST DOMESTIC QTH
74	NRAU-BALTIC-CW	TRUE	FALSE	TRUE	FALSE	RST QSO NUMBER AND DOMESTIC QTH
75	NRAU-BALTIC-SSB	TRUE	FALSE	TRUE	FALSE	RST QSO NUMBER AND DOMESTIC QTH
76	NZ FIELD DAY	TRUE	TRUE	TRUE	TRUE	NZ FIELD DAY
77	OCEANIA-DX-CW	TRUE	TRUE	TRUE	TRUE	RST QSO NUMBER
78	OCEANIA-DX-SSB	TRUE	TRUE	TRUE	TRUE	RST QSO NUMBER
79	OHIO QSO PARTY	TRUE	TRUE	FALSE	TRUE	RST QSO NUMBER AND DOMESTIC QTH
80	OK-OM DX	TRUE	FALSE	TRUE	FALSE	RST QSO NUMBER OR DOMESTIC QTH
81	OZCHR	TRUE	TRUE	TRUE	FALSE	RST ZONE OR SOCIETY
82	OZCHR-TEAMS	TRUE	TRUE	TRUE	FALSE	RST ZONE OR SOCIETY
83	PACC	TRUE	FALSE	TRUE	FALSE	RST QSO NUMBER OR DOMESTIC QTH
84	QCWA GOLDEN	FALSE	FALSE	FALSE	FALSE	QSO NUMBER NAME CHAPTER AND QTH
85	QCWA	TRUE	TRUE	FALSE	FALSE	QSO NUMBER NAME CHAPTER AND QTH
86	R4N-CHAMP	TRUE	TRUE	TRUE	TRUE	QSO NUMBER AND ZONE
87	R4W-CHAMP	TRUE	FALSE	FALSE	FALSE	QSO NUMBER DOMESTIC QTH
88	R9W-UW9WK-MEMORIAL	TRUE	FALSE	FALSE	FALSE	QSO NUMBER AND ZONE
89	RAC CANADA WINTER	TRUE	TRUE	TRUE	TRUE	RST QSO NUMBER OR DOMESTIC QTH
90	RADIO-160	FALSE	TRUE	FALSE	FALSE	RST QSO NUMBER AND DOMESTIC QTH
91	RADIO-MEMORY	TRUE	TRUE	FALSE	FALSE	RST AGE AND POSSIBLE SK
92	RADIO-ONLY	TRUE	TRUE	FALSE	FALSE	RST AGE
93	RADIO-VHF-FD	TRUE	TRUE	FALSE	FALSE	RST QSO NUMBER AND GRID SQUARE
94	RADIO-YOC	TRUE	FALSE	FALSE	FALSE	QSO NUMBER AND PREVIOUS QSO NUMBER
95	RAEM	TRUE	FALSE	FALSE	FALSE	QSO NUMBER AND GEO COORDINATES
96	RDAC	TRUE	TRUE	TRUE	FALSE	RST DOMESTIC QTH OR QSO NUMBER
97	RDXC	TRUE	TRUE	TRUE	FALSE	RST DOMESTIC QTH OR QSO NUMBER
98	REF-CW	TRUE	FALSE	TRUE	FALSE	RST AND QSO NUMBER OR FRENCH DEPARTMENT

#	CONTEST	QSO BY BAND	QSO BY MODE	MULT BY BAND	MULT BY MODE	EXCHANGE RECEIVED
99	REF-SSB	TRUE	FALSE	TRUE	FALSE	RST AND QSO NUMBER OR FRENCH DEPARTMENT
100	REGION 1 FIELD DAY	TRUE	TRUE	TRUE	FALSE	RST QSO NUMBER
101	REGION 1 FIELD DAY-RCC-CW	TRUE	FALSE	TRUE	FALSE	RST QSO NUMBER
102	REGION 1 FIELD DAY-RCC-SSB	TRUE	FALSE	TRUE	FALSE	RST QSO NUMBER
103	RF-CHAMP-CW	TRUE	FALSE	TRUE	FALSE	QSO NUMBER AND ZONE
104	RF-CHAMP-SSB	TRUE	FALSE	TRUE	FALSE	QSO NUMBER AND ZONE
105	RF-CUP-CW	TRUE	FALSE	TRUE	FALSE	QSO NUMBER AND GRID
106	RF-CUP-SSB	TRUE	FALSE	TRUE	FALSE	QSO NUMBER AND GRID
107	ROPOCO	TRUE	FALSE	FALSE	FALSE	RST AND POSTAL CODE
108	RSGB-160	FALSE	FALSE	FALSE	FALSE	RST DOMESTIC QTH OR QSO NUMBER
109	RSGB-IOTA	TRUE	TRUE	TRUE	TRUE	RST QSO NUMBER AND POSSIBLE DOMESTIC QTH
110	SAC-CW	TRUE	FALSE	TRUE	FALSE	RST QSO NUMBER
111	SAC-SSB	TRUE	FALSE	TRUE	FALSE	RST QSO NUMBER
112	SALMON RUN	TRUE	TRUE	FALSE	FALSE	RST DOMESTIC OR DX QTH
113	SOUTH AMERICAN WW	TRUE	TRUE	TRUE	FALSE	RST AND CONTINENT
114	SP DX	TRUE	TRUE	TRUE	FALSE	RST DOMESTIC QTH OR QSO NUMBER
115	SRR-JR	TRUE	FALSE	FALSE	FALSE	QSO NUMBER AND AGE
116	STEW-PERRY	FALSE	FALSE	FALSE	FALSE	RST AND OR GRID
117	TAC	FALSE	FALSE	FALSE	FALSE	RST QSO NUMBER AND POSSIBLE DOMESTIC QTH
118	TEN TEN	TRUE	TRUE	FALSE	FALSE	NAME QTH AND POSSIBLE TEN TEN NUMBER
119	TENNESSEE QSO PARTY	TRUE	TRUE	TRUE	FALSE	RST DOMESTIC QTH
120	TEXAS QSO PARTY	TRUE	TRUE	FALSE	FALSE	RST DOMESTIC OR DX QTH
121	TOEC	TRUE	FALSE	TRUE	FALSE	RST DOMESTIC QTH
122	UBA-DX-CW	TRUE	FALSE	TRUE	FALSE	RST QSO NUMBER AND POSSIBLE DOMESTIC QTH
123	UBA-DX-SSB	TRUE	FALSE	TRUE	FALSE	RST QSO NUMBER AND POSSIBLE DOMESTIC QTH
124	UCG	TRUE	FALSE	TRUE	FALSE	RST QSO NUMBER
125	UKRAINE CHAMPIONSHIP	TRUE	FALSE	TRUE	FALSE	QSO NUMBER DOMESTIC QTH

#	CONTEST	QSO BY BAND	QSO BY MODE	MULT BY BAND	MULT BY MODE	EXCHANGE RECEIVED
126	UKRAINIAN	TRUE	TRUE	TRUE	FALSE	RST QSO NUMBER OR DOMESTIC QTH
127	UN DX	TRUE	TRUE	TRUE	FALSE	RST DOMESTIC QTH OR QSO NUMBER
128	URAL-CUP	TRUE	TRUE	TRUE	FALSE	QSO NUMBER DOMESTIC QTH
129	WAG	TRUE	TRUE	TRUE	FALSE	RST QSO NUMBER OR DOMESTIC QTH
130	WISCONSIN QSO PARTY	TRUE	TRUE	FALSE	FALSE	RST DOMESTIC QTH
131	WRTC	TRUE	TRUE	TRUE	FALSE	RST ZONE OR SOCIETY
132	WW PMC	TRUE	TRUE	TRUE	TRUE	RST ZONE OR SOCIETY
133	WWL	TRUE	TRUE	TRUE	FALSE	RST AND GRID
134	XMAS	TRUE	FALSE	TRUE	FALSE	RST QSO NUMBER AND RANDOM CHARACTERS
135	YO DX	TRUE	TRUE	TRUE	FALSE	RST QSO NUMBER OR DOMESTIC QTH
136	YUDX	TRUE	FALSE	TRUE	FALSE	RST ZONE

1.3 System Requirements

Supported Operating Systems

Windows 98SE, 2000, XP, Vista, Windows 7

Memory Requirements

16 MB of memory, more is desirable

CPU Requirements

200 MHz CPU clock; faster is desirable – especially if using DVP recording of contests.

COM, LPT, USB and sound requirements

One COM port per Radio controlled by program.

One LPT port per radio if Band selection done by program.

One Com port for rotator control if used.

One Com port for Network if used.

Internet connection required for DX Cluster use.

USB to COM adapters can be used.

Internal sound card or USB sound card required for DVP.

Sound card should allow line-in [or mic] and line-out [or speaker]

Computer speaker used for CW monitoring

1.4 Files used by the Program

1.5 Program Installation

To get started go to the TR4W homepage at: <http://www.tr4w.com/>. Click on “DOWNLOAD” to bring up a list of TR4W versions for several languages. Select the latest release in the language that you wish to use. This manual is written for users of the English version but should be useful to those using other languages, As of this writing the current English version release is 4.239. Click on “tr4w_setup_4_237.zip” to initiate a download of a compressed (zip) file which you should save. When the download is completed and saved, extract the file and you will see a window like this:

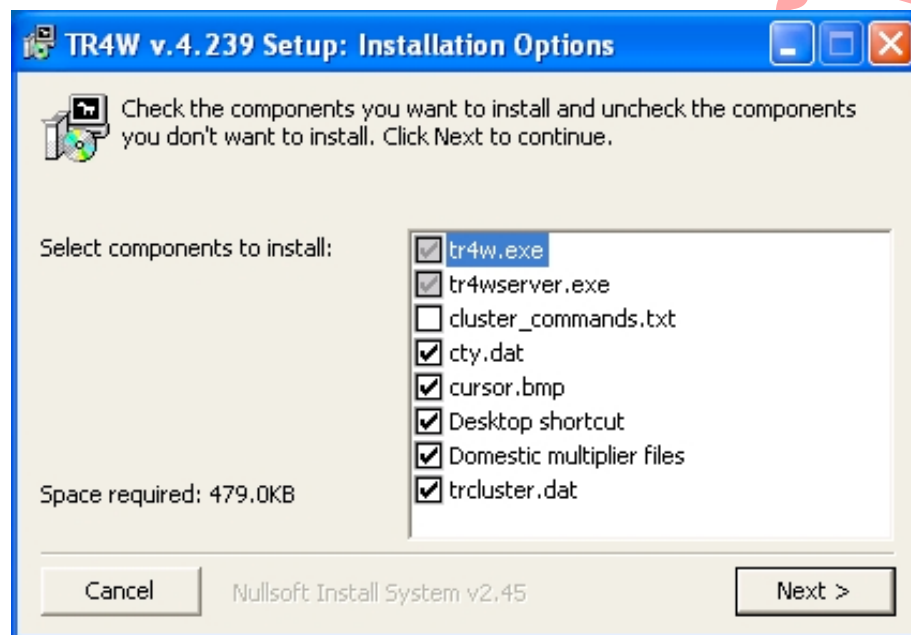

Click on next to continue the installation.

When click on next you will be asked where you want to store the TR4W program. Windows suggests that you store it in the Program Files folder

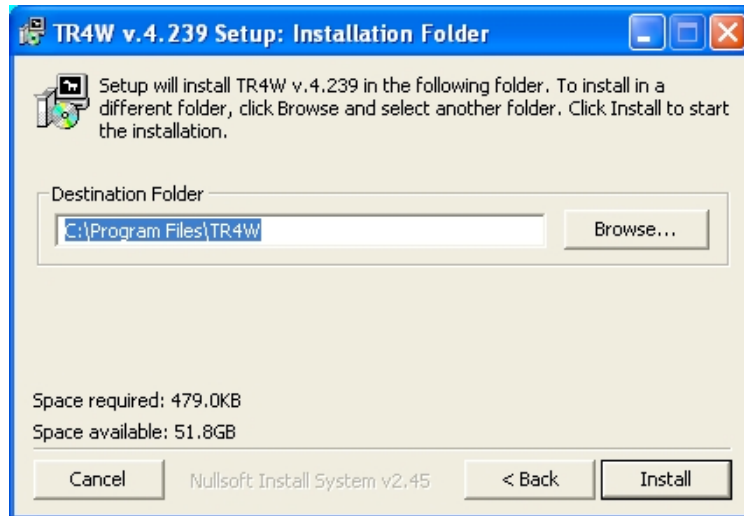

I suggest that you store it in a different folder to simplify getting into to the folder if you want to make changes or to look at a file after you have been using TR4W for a while.

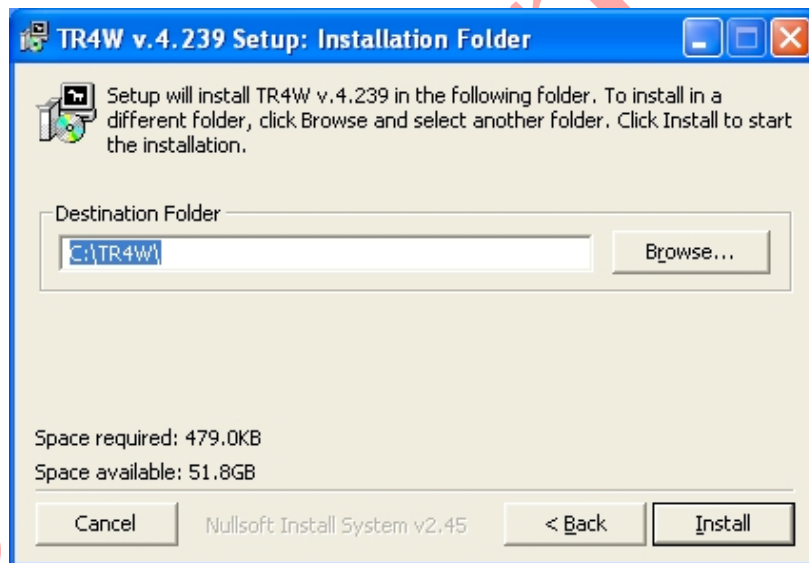

Click on Next and the program will install. When the installation is completed a TR4W icon will appear on your desktop. Clicking on the icon starts the program.



1.6 Program Windows -- Names and Colors

1.7 List of Hot Keys

1.7.1 Alt+ keys

<u>Alt- Sub menu</u>	<u>Shortcut Keys</u>	<u>Description</u>
Increment time		Alt + A Set Alarm
Alarm	Alt+A	Alt + B Band Up
Auto-CQ resume	Alt+C	Alt + C Resume Auto-CQ
Dupe check	Alt+D	Alt + D Check Dupes
Edit	Alt+E	Alt + E Edit
Save to floppy	Alt+F	Alt + F Backup log to disk
Swap mult view	Alt+G	Alt + G Switch Multiplier View
Increment number	Alt+I	Alt + H User's Guide
Toogle multiplier bell	Alt+J	Alt + I Increment number
Kill CW	Alt+K	Alt + J Config Com Window
Search log	Alt+L	Alt + K Disable CW
Transmit frequency	Alt+N	Alt + L Search Log
Reminder	Alt+O	Alt + M Set Mode
Auto-CQ	Alt+Q	Alt + N Set Transmit Frequency
Toggle rigs	Alt+R	Alt + O Set Reminder
CW speed	Alt+S	Alt + P Program Messages
Set system date/time	Alt+T	Alt + Q Setup Auto CQ
Initialize QSO	Alt+W	Alt + R Toggle Radios
Reset wakeup	Alt+Ctrl+W	Alt + S Set CW Speed
Delete the last QSO	Alt+Y	Alt + T Set Time
Initial exchange	Alt+Z	Alt + V Band Down
Toggle sidetone	Alt+=	Alt + W Clear Call Window
Toogle autosend	Alt+-	Alt + X Exit program
Band Up	Alt+B	Alt + Y Delete last entry
Band Down	Alt+V	Alt + Z The exchange number
SSB/CW mode	Alt+M	Alt + - Toggle Auto-CQ
		Alt + = Toggle sidetone

1.7.2 Ctrl+ keys

<u>Ctrl- Sub menu</u>	<u>Shortcut Keys</u>	<u>Description</u>
Send Keyboard Input	Ctrl+A	Transfer from the keyboard
Communicate with packet port	Ctrl+B	Communicate with Packet port
Clear multsheet	Ctrl+C	Clear the table of multipliers
Auto QSL Interval (Decrease)	Ctrl+D	Reduce Auto QSL Interval
Auto QSL Interval (Increase)	Ctrl+I	Increase Auto QSL Interval
Clear dupesheet	Ctrl+K	Clear the list of repetitions
View / Edit log	Ctrl+L	View / Edit log
Note	Ctrl+N	Create note
Missing mults report	Ctrl+O	Show missing Mults
Redo possible calls	Ctrl+P	possible call signs
QTC functions	Ctrl+Q	QTC functions
Recall last entry	Ctrl+R	Restore last entry
SH/DX [callsign]	Ctrl+S	SH / DX [call sign]
View packet spots	Ctrl+U	Show packet spots
Execute configuration file	Ctrl+V	Refresh band map
Refresh bandmap	Ctrl+Y	Alternate CQ on two radios
Dualing CQs	Ctrl+-	Cursor in the band map window
Cursor in bandmap window	Ctrl+End	QSO enter with no sending
Cursor in DX Cluster window	Ctrl+Home	Cursor in the window DX Cluster
QSO with no CW	Ctrl+Enter	Open CT1BOH window
CT1BOH info screen	Ctrl+]	Toglg insert/delete
Add bandmap place holder	Ctrl+Ins	
Additional information ▶		

1.7.3 Additional Ctrl + keys

<u>Shortcut Keys</u>	<u>Description</u>
Ctrl +1	Number of QSO
Ctrl +2	Call
Ctrl +3	Speed CW
Ctrl +4	Range
Ctrl +5	
Ctrl +6	
Ctrl +7	Clear the table of multipliers
Ctrl +8	Reduce Auto QSL Interval
Ctrl +9	Cursor in the map window range
Ctrl + PgDn	Reduce CW speed to idle radio
Ctrl + PgUp	Increase CW speed to idle radio

1.7.4 Shift+Ctrl Keys

<u>Shortcut Keys</u>	<u>Description</u>
Shift + ' 	Send a message
Shift + Ctrl + `	Map of the range
Shift + Ctrl +0	Open MP3 recorder
Shift + Ctrl +1	Sheet repeats
Shift + Ctrl +2	Function keys
Shift + Ctrl +3	TRMASTER.DTA
Shift + Ctrl +4	By default
Shift + Ctrl +5	Radio 1
Shift + Ctrl +6	Radio 2
Shift + Ctrl +7	Intercom
Shift + Ctrl +8	Send a report to GETSCORES.ORG
Shift + Ctrl +9	Station
Shift + Tab	CQ mode

1.7.5 Ctrl+Alt+ Keys

<u>Shortcut Keys</u>	<u>Description</u>
Ctrl + Alt +1	Radio 1
Ctrl + Alt +2	Radio 2
Ctrl + Alt + M	Tiling
Ctrl + Alt + S	Compare and synchronize the logs
Ctrl + Alt + T	Time Synchronization
Ctrl + Alt + W	Reset the Alarm

1.7.6 Special Keys

<u>Shortcut Keys</u>	<u>Description</u>
Del	Delete the selected spot
Enter	Enter QSO and transmit
Esc	Exit S & P mode
Ins	Toggle insert/replace
Pause	The focus in the main program window
PgDn	Reduce CW speed
PgUp	Increase CW speed
Tab	Enter S & P mode
`	Send spot to cluster

1.8 Suggested Interface Circuits

1.8.1 CW Interface

DB-25 Pin	DB-9 Pin	Signal
2	3	Serial output from CPU
3	2	Serial input to CPU
7	5	Ground

TNC/Radio/Network Wiring

DB-25 Pin	DB-9 Pin	Signal
20	4	CW key output (use circuit A)
4	7	PTT out (use another circuit A)
7	5	Ground

CW Interface

Some TNCs or radio interfaces may require one or both of the following jumpers to work properly (these jumpers are not necessary on the computer side of the serial interface cable):

DB-25: Connect pin 6 to 8; connect pin 4 to 5;
DB-9: Connect pin 1 to 6; connect pin 4 to 7.

It has also been reported that some rigs (notably the Kenwood TS-870) require that the CTS and RTS lines be carried between the rig and the computer. On a DB25, these are pins 4 and 5; on a DB9 they are pins 7 and 8.

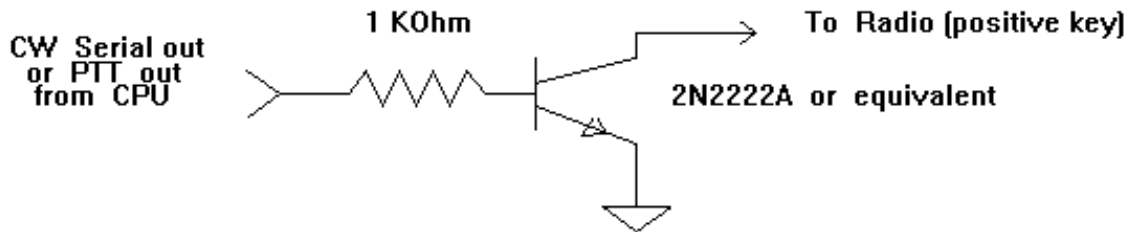

Circuit A: Use this for serial port CW and PTT

Preliminary

DB-25 Pin	Signal
1	Strobe. Goes to emitter of all Circuit B transistors
2	External relay band output bit 0 (see RADIO ONE BAND OUTPUT PORT or DVK abort)
3	DVK output #1 (positive-going pulse - see DVK PORT).
4	DVK output #2
5	DVK output #3
6	DVK output #4
7	External relay band output bit 1 / DVK output #5
8	External relay band output bit 2 / DVK output #6
9	External relay band output bit 3
12	Dit paddle contact input. Connect a 10K pullup resistor between this pin and pin 14
13	Dah paddle contact input. Connect a 10K pullup resistor between this pin and pin 14
14	+5 V pullup. If you are using the paddle or footswitch inputs, connect 10K pullup resistors between this pin and the paddle or foot switch inputs (one resistor per input). Pin 14 can also be used to control an external relay to switch between two transmitters. See RELAY CONTROL PORT for more information
15	Foot switch input. See FOOT SWITCH PORT for more information
16	PTT output. Use separate circuit B; goes to 1K resistor
17	CW output. Use separate circuit B; goes to 1K resistor
18	Ground for CW and PTT (connect to rig)
25	Ground for paddle

Parallel Port Interface

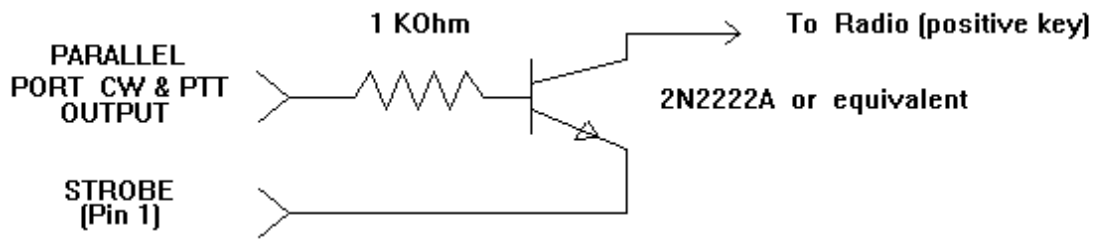

Circuit B: Use this for parallel port CW and PTT

The next two pages contain details of an adapter from NOSS. Thanks to NOSS for the bitmap files used to generate these two pages.

Preliminary

Parallel Port CW and PTT Keying Adapter and Paddle Input for TRLog Keyer

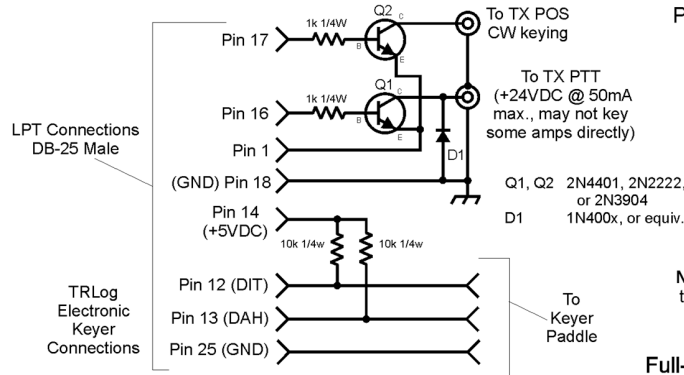

Pinouts for transistors

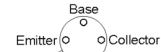

Type: TO-18



Type: TO-92

NOTE: For TO-92 (plastic) transistors, use the three holes which are in-line

Full-size PC board drawing

(PC board size is 1-7/16" x 3/4". Adjust the size of your negative to obtain these measurements.)

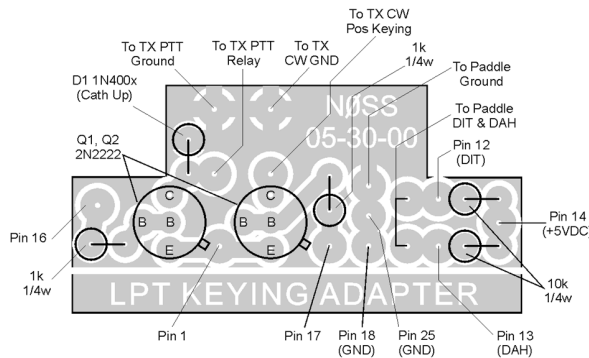

Enlarged (X2) PC board w/parts layout (shown from foil side of PC board, components mount on non-foil side)

Pre-cut & stripped wire lengths for connecting this PC board to a *male* DB-25 connector: (Strip 1/8" of insulation from each end, then tin the wire)

Pin number:	1	12	13	14	16	17	18	25	TX Key	TX GND
Wire Length:	3/4"	3/4"	7/8"	1-3/4"	3/4"	1"	3/4"	7/8"	1-1/4"	1-1/4"

Wire Color: _____

TX Key Output Conn. Mtg. Plate (see text)

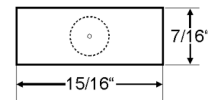

To prepare the DB-25 male connector: With the connector assembled, drill holes in the center of the two diagonal sides. The size of the holes should be no larger than the outside diameter of the wires to be used for the PTT output and Electronic Keyer paddle input.

The TX Keying Output Jack is a chassis-mount RCA jack. Cut a mounting plate (15/16" x 7/16") out of left over PC board and drill a hole in the middle of this plate. The hole should be just large enough to pass the mounting shank of the chassis-mount phono connector. This connector and mounting plate will slip in the space immediately behind the normal cable hole in the D-25 connector, with the RCA connector protruding out of the cable hole for easy access.

The PC board connects to the DB-25 via short, flexible, wires (see wire lengths table). Once completed, the DB-25 should be positioned (with respect to the PC board) so pins 1-13 are at the bottom and pins 14-25 are on the top. Solder the wires to ALL of the PC board holes first, and then solder the wires to D-25 pins 1, 12 & 13 first (with DB-25 pins 1-13 on top and the PC board upside down). Then turn both the DB-25 and the PC board over and complete soldering the wires to pins 14, 16, 17, 18 & 25.

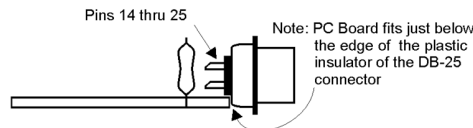

Complete the assembly by installing the two wires going to the TX key output jack and the PTT and Paddle input wires. Attach connectors appropriate to your installation to the ends of these wires.

d:\cdr\lpt keying adapter.cdr 01/01/2002 NOSS

Parallel Port CW and PTT Keying Adapter and Paddle Input for Internal Keyer from NOSS

NOTE: if you use a METAL (or a 'METALIZED' plastic hood), BE SURE TO place some form of insulator between the top AND bottom of the PC board and the metal inside of the hood to prevent the components from shorting to the hood. NON-METALLIC hoods are strongly recommended!

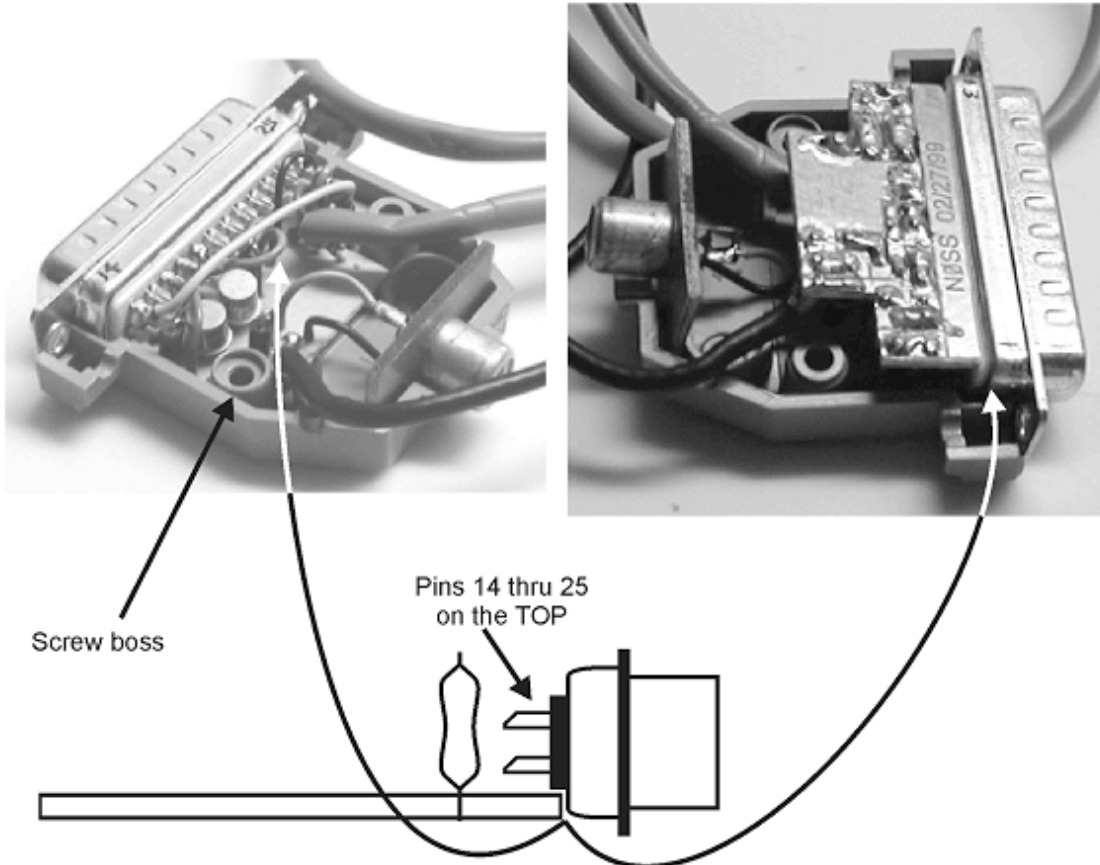

Note: The PC Board does NOT fit between the DB-25 pins, but just below the edge of the plastic insulator of the DB-25 connector. It will be held in place by the two screw bosses in the shell of the connector once the shell has been fitted to the connector.

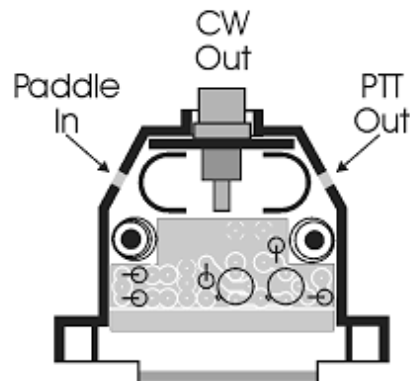

1.9 TR Log Configuration Statements dropped from TR4W

A total of 83 configuration that are used in TR Log were dropped from TR4W because they were not required.

ASK IF CONTEST OVER	PACKET SPOT COMMENT
AUTO ALT-D ENABLE	PACKET SPOT DISABLE
BACKCOPY ENABLE	PACKET SPOT EDIT ENABLE
BIG REMAINING LIST	PACKET SPOT KEY
CALL WINDOW POSITION	PACKET SPOT PREFIX ONLY
COPY FILES	PACKET SPOTS
CQ MENU	PADDLE BUG ENABLE
CURTIS KEYSER MODE	PARTIAL CALL LOAD LOG ENABLE
DISPLAY MODE	PARTIAL CALL MULT INFO ENABLE
DUPE SHEET ENABLE	PRINTER ENABLE
DVK PORT	QUICK QSL KEY
EIGHT BIT PACKET PORT	QUICK QSL MESSAGE
EX MENU	RADIO ONE COMMAND PAUSE
EXCHANGE WINDOW S&P BACKGROUND	RADIO ONE ID CHARACTER
FILTER RADIO MESSAGE LENGTH	RADIO ONE TRACKING ENABLE
FT1000MP CW REVERSE	RADIO ONE UPDATE SECONDS
HOUR OFFSET	RADIO TWO COMMAND PAUSE
ICOM COMMAND PAUSE	RADIO TWO ID CHARACTER
ICOM RESPONSE TIMEOUT	RADIO TWO TRACKING ENABLE
INPUT CONFIG FILE	RADIO TWO UPDATE SECONDS
JST RESPONSE TIMEOUT	RTTY PORT
K1EA NETWORK ENABLE	RTTY RECEIVE STRING
K1EA STATION ID	RTTY SEND STRING
KENWOOD RESPONSE TIMEOUT	SCORE POSTING ID
LOG FILE NAME	SEND ALT-D SPOTS TO PACKET
MODEM PORT BAUD RATE	SEND QSO IMMEDIATELY
MODEM PORT	SERIAL 5 PORT ADDRESS
MOUSE ENABLE	SERIAL 6 PORT ADDRESS
MP3 RECORDER SAMPLERATE	SHOW LOG GRIDLINES
MULTI PORT BAUD RATE	SHOW SEARCH AND POUNCE
MULTI PORT	SIMULATOR ENABLE
MULTI RETRY TIME	TAB MODE
MULTI UPDATE MULT DISPLAY	TOTAL OFF TIME
PACKET ADD LF	TOTAL SCORE MESSAGE
PACKET AUTO CR	UPDATE RESTART FILE ENABLE
PACKET BAND SPOTS	USE BIOS KEY CALLS
PACKET BAUD RATE	USE IRQS
PACKET BEEP	VGA DISPLAY ENABLE
PACKET LOG FILENAME	VISIBLE DUPESHEET

PACKET PORT BAUD RATE	WIDE FREQUENCY DISPLAY
PACKET PORT	YAESU RESPONSE TIMEOUT
PACKET RETURN PER MINUTE	

1.10 Configuration Statements Added in TR4W

TR4W has added 87 new configuration statements to the original set of TR Log statements.

ALLOW AUTO UPDATE	RADIO ONE ICOM FILTER BYTE
AUTO-CQ DELAY TIME	RADIO ONE KEYER DTR
BANDMAP ITEM HEIGHT	RADIO ONE KEYER RTS
BANDMAP ITEM WIDTH	RADIO ONE WIDE CW FILTER
BOLD FONT	RADIO TWO CAT DTR
CATEGORY-BAND	RADIO TWO CAT RTS
CATEGORY-MODE	RADIO TWO FT1000MP CW REVERSE
CATEGORY-OPERATOR	RADIO TWO ICOM FILTER BYTE
CATEGORY-POWER	RADIO TWO KEYER DTR
CATEGORY-TRANSMITTER	RADIO TWO KEYER RTS
COMPLETE CALLSIGN MASK	RADIO TWO WIDE CW FILTER
COMPUTER NAME	ROW COUNT
CONNECTION AT STARTUP	SCORE POSTING URL
CONNECTION COMMAND	SCORE READING URL
CUSTOM CARET	SERVER ADDRESS
DIT DAH RATIO	SERVER PASSWORD
DUPE SHEET AUTO RESET	SERVER PORT
DVP RECORDER	SHOW DOMESTIC MULTIPLIER NAME
HAND LOG MODE	SHOW FREQUENCY IN LOG
INCLUDE F-KEY NUMBER	SHOW GRIDLINES
LATEST CONFIG FILE	SHOW TYPED CALLSIGN
LPT1 BASE ADDRESS	STATIONS CALLSIGNS MASK
LPT2 BASE ADDRESS	TELNET SERVER
LPT3 BASE ADDRESS	USE CONTROL PORT
MAIN FONT	USE RECORDED SIGNS
MINITOUR DURATION	WK AUTOSPACE
MISSINGCALLSIGNS FILE ENABLE	WK CT SPACING
MMTTY ENGINE	WK DIT DAH RATIO
MP3 PATH	WK ENABLE
MP3 PLAYER	WK FIRST EXTENSION
MP3 RECORDER BITRATE	WK IGNORE SPEED POT
MP3 RECORDER DURATION	WK KEYER COMPENSATION
MP3 RECORDER ENABLE	WK KEYER MODE
NET STATUS UPDATE INTERVAL	WK LEADIN TIME
NO BORDER	WK PADDLE ONLY SIDETONE
NO CAPTION	WK PADDLE SWAP
NO COLUMN HEADER	WK PADDLE SWITCHPOINT
PTT LOCKOUT	WK PORT

PTT VIA COMMANDS	WK SIDETONE FREQUENCY
QZB RANDOM OFFSET ENABLE	WK SIDETONE ENABLE
R150S MODE	WK TAIL TIME
RADIO ONE CAT DTR	WK WEIGHT
RADIO ONE CAT RTS	WINDOW SIZE
RADIO ONE FT1000MP CW REVERSE	

1.11 Configuration Statements List

When TR4W is first installed all of the Configuration Statement values are set to their default Value. As the User sets things up for a particular station and a particular contest they change the default Values of various statements. Each change causes a Configuration Statement to be written or re-written in either the TR4W.INI file or the CONTESTNAME.CFG file. If you wish to reset everything in the program to the default values you need only delete both the TR4W.INI file and the CONTESTNAME.CFG file and you will have returned to the state that existed when you first installed the TR4W program. If, after setting things up for a particular contest and station, you want to record the settings that you have made and the messages you created you will need to make a copy of TR4W.INI file and the CONTESTNAME.CFG file and then rename the copies.

The ability to start with a “clean page” and “keep a copy of a desired setup” is extremely useful when you plan to operate in more than one contest. You can make copies of a stored .INI file and its matching .CFG and then rename them for use again in a contest at a later time.

1.12 Using Saved Configuration Statements.

To re-use previously created and used Configuration Statement files for another contest do the following:

1. Take the copy of the TR4W.INI file you wish to use and rename it TR4W.INI . Open the Settings folder in the TR4W folder and paste the new TR4W.INI file into it. Since there is an existing one already there you will be asked if you wish to overwrite TR4W.INI and you select YES.
2. Start TR4W and when the opening screen appears select the contest that you plan to operate. Fill in all of the places that have blanks on the right hand side of the opening screen and then click on OK. [you will not be able to click on OK unless you have filled in all of the information needed].
3. If a Contest folder for that contest with the same year already exists you will be asked if you wish to overwrite the existing file. Since you want to use a different .CFG file you will click on OK. If no folder with that name already exists the program will take you to step 4.
4. The TR4W Main Window will open. Open the FILE menu of the Main Window and select Open log directory. In the window that opens you will see a .CFG file and perhaps an .RST file and a .TRW file, Delete the .RST and .TRW files. Click on the .CFG file to open it. If you are asked what program you wish to use to open the .CFG file select Notepad. Notepad is a text editor. When you open the .CFG file you will see Configuration Statements with Values that correspond to the entries you made when you selected the contest. Type <Ctrl+A> which will select all of lines in the file. Then type <Ctrl+C> which copies all of the lines that were selected.

5. Next find the .CFG file you wish to use and open it with Notepad. Put the cursor on the first line in the file and type <Ctrl+V>. That will paste all of the lines you just copied into .CFG file you want to use. Now look the first CONTEST NAME = 'name' statement in the file. Delete all of the lines following that one up to and including the next CONTEST NAME = 'name' statement.
6. Save the modified file in the Contest folder in the TR4W folder. Use the name of the .CFG file that is already in the folder. You will be asked if you wish to overwrite the existing file and you should select YES.
7. Close the folders that you opened which will bring you back to the Main Window of TR4W. If you check the function key messages you will see that the default messages have been changed to the ones you had created when you used TR4W previously. Just to be sure you should exit from TR4W and then restart it. That will cause all of the operating parameters used by TR4W to be set to the values assigned by the Configuration Statements of the TR4W.INI file and .CFG file that you imported from the saved versions.

1.13 Configuration Statement Table

Definition Section	Crtr+J #	Configuration Statement	Default value	Hot Key	Stored in	Changed by
1.14.1	1	ADD DOMESTIC COUNTRY	NONE		TR4W.INI	Contest
1.14.2	2	ALL CW MESSAGES CHAINABLE	FALSE	Ctrl+J	TR4W.INI	Statement
1.14.3	3	ALLOW AUTO UPDATE	TRUE	Ctrl+J	TR4W.INI	Statement
1.14.4	4	ALT-D BUFFER ENABLE	FALSE	Ctrl+J	TR4W.INI	Statement
1.14.5	5	ALWAYS CALL BLIND CQ	FALSE	Ctrl+J	TR4W.INI	Statement
1.14.6	6	ASK FOR FREQUENCIES	FALSE	Ctrl+J	TR4W.INI	Statement
1.14.7	7	AUTO CALL TERMINATE	FALSE	Ctrl+J	TR4W.INI	Statement
1.14.8	8	AUTO DISPLAY DUPE QSO	FALSE	Ctrl+J	TR4W.INI	Statement
1.14.9	9	AUTO DUPE ENABLE CQ	TRUE	Ctrl+J	TR4W.INI	Statement
1.14.10	10	AUTO DUPE ENABLE S AND P	TRUE	Ctrl+J	TR4W.INI	Statement
1.14.11	11	AUTO QSL INTERVAL	0	Ctrl+J	TR4W.INI	Statement
1.14.12	12	AUTO QSO NUMBER DECREMENT	FALSE	Ctrl+J	TR4W.INI	Statement
1.14.13	13	AUTO RETURN TO CQ MODE	TRUE	Ctrl+J	TR4W.INI	Statement
1.14.14	14	AUTO S&P ENABLE	500	Ctrl+J	TR4W.INI	Statement
1.14.15	15	AUTO S&P ENABLE SENSITIVITY	FALSE	Ctrl+J	TR4W.INI	Statement
1.14.16	16	AUTO SEND CHARACTER COUNT	0	Ctrl+J	TR4W.INI	Statement
1.14.17	17	AUTO TIME INCREMENT	0	Ctrl+J	TR4W.INI	Statement
1.14.18	18	AUTO-CQ DELAY TIME	3000	Ctrl+J	TR4W.INI	Statement
1.14.19	19	BAND	160	Alt+B,Alt+V	CONTEST.CFG	XX
1.14.20	20	BAND MAP ALL BANDS	FALSE	Ctrl+J	TR4W.INI	Statement
1.14.21	21	BAND MAP ALL MODES	FALSE	Ctrl+J	TR4W.INI	Statement
1.14.22	22	BAND MAP CALL WINDOW ENABLE	TRUE	Ctrl+J	TR4W.INI	Statement
1.14.23	23	BAND MAP CUTOFF FREQUENCY	0	Ctrl+J	TR4W.INI	Statement
1.14.24	24	BAND MAP DECAY TIME	60	Ctrl+J	TR4W.INI	Statement
1.14.25	25	BAND MAP DISPLAY CQ	TRUE	Ctrl+J	TR4W.INI	Statement
1.14.26	26	BAND MAP DUPE DISPLAY	TRUE	Ctrl+J	TR4W.INI	Statement
1.14.27	27	BAND MAP ENABLE	FALSE	Ctrl+J	TR4W.INI	Statement
1.14.28	28	BAND MAP GUARD BAND	200	Ctrl+J	TR4W.INI	Statement
1.14.29	29	BAND MAP MULTS ONLY	FALSE	Ctrl+J	TR4W.INI	Statement
1.14.30	30	BAND MAP SPLIT MODE	BY CUTOFF FREQ	Ctrl+J	TR4W.INI	Statement

Definition Section	Ctrl+J #	Configuration Statement	Default value	Hot Key	Stored in	Changed by
1.14.31	31	BANDMAP ITEM HEIGHT	17	Ctrl+J	TR4W.INI	Statement
1.14.32	32	BANDMAP ITEM WIDTH	139	Ctrl+J	TR4W.INI	Statement
1.14.33	33	BEEP ENABLE	TRUE	Ctrl+J	TR4W.INI	Statement
1.14.34	34	BEEP EVERY 10 QSOS	FALSE	Ctrl+J	TR4W.INI	Statement
1.14.35		BOLD FONT	TRUE	Ctrl+J	TR4W.INI	Statement
1.14.36	35	BROADCAST ALL PACKET DATA	TRUE	Ctrl+J	TR4W.INI	Statement
1.14.37		CALL OK NOW CW MESSAGE		Alt+P, O	CONTEST.CFG	Function Key
1.14.38		CALL OK NOW MESSAGE		Alt+P, O	CONTEST.CFG	Function Key
1.14.39		CALL OK NOW SSB MESSAGE		Alt+P, O	CONTEST.CFG	Function Key
1.14.40	36	CALL WINDOW SHOW ALL SPOTS	FALSE	Ctrl+J	TR4W.INI	Statement
1.14.41	37	CALLSIGN UPDATE ENABLE	FALSE	Ctrl+J	CONTEST.CFG	Statement
1.14.42	38	CATEGORY-ASSISTED	NON-ASSISTED	Ctrl+J	CONTEST.CFG	Statement
1.14.43	39	CATEGORY-BAND	ALL	Ctrl+J	CONTEST.CFG	Statement
1.14.44	40	CATEGORY-MODE	CW	Ctrl+J	CONTEST.CFG	Statement
1.14.45	41	CATEGORY-OPERATOR	SINGLE-OP	Ctrl+J	CONTEST.CFG	Statement
1.14.46	42	CATEGORY-POWER	HIGH	Ctrl+J	CONTEST.CFG	Statement
1.14.47	43	CATEGORY-TRANSMITTER	ONE	Ctrl+J	CONTEST.CFG	Statement
1.14.48	44	CHECK LOG FILE SIZE	FALSE	Ctrl+J	TR4W.INI	Statement
1.14.49	45	CLEAR DUPE SHEET	FALSE	Ctrl+K	TR4W.INI	XX
1.14.50	46	CODE SPEED	35	Ctrl+J	TR4W.INI	Statement
1.14.51	47	COLUMN DUPESHEET ENABLE	FALSE	Ctrl+J	TR4W.INI	Statement
1.14.52	48	COMPLETE CALLSIGN MASK	NONE	Ctrl+C,E,O	TR4W.INI	XX
1.14.53	49	COMPUTER ID		Ctrl+J	TR4W.INI	Statement
1.14.54	50	COMPUTER NAME	New	Ctrl+J	TR4W.INI	Statement
1.14.55	51	CONFIRM EDIT CHANGES	TRUE	Ctrl+J	TR4W.INI	Statement
1.14.56	52	CONNECTION AT STARTUP	FALSE	Ctrl+J	TR4W.INI	Statement
1.14.57	53	CONNECTION COMMAND	NONE	Ctrl+J	TR4W.INI	Statement
1.14.58	54	CONTACTS PER PAGE	50	Ctrl+J	TR4W.INI	Statement
1.14.59	57	CONTEST	NONE		TR4W.INI	Contest
1.14.60	55	CONTEST NAME	NONE		TR4W.INI	Contest
1.14.61	56	CONTEST TITLE	DUMMY CONTEST		TR4W.INI	Contest
1.14.62	58	COUNT DOMESTIC COUNTRIES	FALSE	Ctrl+J	TR4W.INI	Statement
1.14.63	59	COUNTRY INFORMATION FILE	NONE	Ctrl+J	TR4W.INI	Statement
1.14.64		CQ CW EXCHANGE NAME KNOWN		Alt+P, O	CONTEST.CFG	Function Key
1.14.65		CQ CW EXCHANGE		Alt+P, O	CONTEST.CFG	Function Key
1.14.66		CQ EXCHANGE NAME KNOWN		Alt+P, O	CONTEST.CFG	Function Key
1.14.67		CQ EXCHANGE		Alt+P, O	CONTEST.CFG	Function Key
1.14.68		CQ SSB EXCHANGE NAME KNOWN		Alt+P, O	CONTEST.CFG	Function Key
1.14.69		CQ SSB EXCHANGE		Alt+P, O	CONTEST.CFG	Function Key
1.14.70	60	CUSTOM CARET	TRUE	Ctrl+J	TR4W.INI	Statement
1.14.71	61	CUSTOM INITIAL EXCHANGE STRING	NONE	Ctrl+J	TR4W.INI	Statement
1.14.72	62	CUSTOM USER STRING	NONE	Ctrl+J	TR4W.INI	Statement
1.14.73	63	CW ENABLE	TRUE	Ctrl+J	TR4W.INI	Statement
1.14.74	64	CW SPEED FROM DATABASE	FALSE	Ctrl+J	TR4W.INI	Statement
1.14.75	65	CW SPEED INCREMENT	3	Ctrl+J	TR4W.INI	Statement
1.14.76	66	CW TONE	700	Ctrl+J	TR4W.INI	Statement
1.14.77	67	DE ENABLE	TRUE	Ctrl+J	TR4W.INI	Statement
1.14.78	68	DIGITAL MODE ENABLE	FALSE	Ctrl+J	TR4W.INI	Statement
1.14.79	69	DISTANCE MODE	KM	Ctrl+J	TR4W.INI	Statement
1.14.80	70	DIT DAH RATIO	3	Ctrl+J	TR4W.INI	Statement
1.14.81	71	DOMESTIC FILENAME	NONE	Ctrl+J	TR4W.INI	Statement
1.14.82	72	DOMESTIC MULTIPLIER	NONE	Ctrl+J	TR4W.INI	Statement
1.14.83	73	DUPE CHECK SOUND	DUPE BEEP	Ctrl+J	TR4W.INI	Statement
1.14.84	74	DUPE SHEET AUTO RESET	TRUE	Ctrl+J	TR4W.INI	Statement
1.14.85	75	DVP ENABLE	FALSE	Ctrl+J	TR4W.INI	Statement
1.14.86	76	DVP PATH	DVP	Ctrl+J	TR4W.INI	Statement
1.14.87	77	DVP RECORDER	NONE	Ctrl+J	TR4W.INI	Statement
1.14.88	78	DX MULTIPLIER	NONE	Ctrl+J	TR4W.INI	Statement

Definition Section	Ctrl+J #	Configuration Statement	Default value	Hot Key	Stored in	Changed by
1.14.89	79	ESCAPE EXITS SEARCH AND POUNCE	TRUE	Ctrl+J	TR4W.INI	Statement
1.14.90	80	EXCHANGE MEMORY ENABLE	TRUE	Ctrl+J	TR4W.INI	Statement
1.14.91	81	EXCHANGE RECEIVED	UNKNOWN	Ctrl+J	TR4W.INI	Statement
1.14.92	82	FARNSWORTH ENABLE	FALSE	Ctrl+J	TR4W.INI	Statement
1.14.93	83	FARNSWORTH SPEED	25	Ctrl+J	TR4W.INI	Statement
1.14.94	84	FLOPPY FILE SAVE FREQUENCY	0	Ctrl+J	TR4W.INI	Statement
1.14.95	85	FLOPPY FILE SAVE NAME	C:\LOGBACK.TRW	Ctrl+J	TR4W.INI	Statement
1.14.96	86	FOOT SWITCH MODE	DISABLED	Ctrl+J	TR4W.INI	Statement
1.14.97	87	FOOT SWITCH PORT	NONE	Ctrl+J	TR4W.INI	Statement
1.14.98	88	FREQUENCY ADDER RADIO ONE	0	Ctrl+J	TR4W.INI	Statement
1.14.99	89	FREQUENCY ADDER RADIO TWO	0	Ctrl+J	TR4W.INI	Statement
1.14.100	90	FREQUENCY MEMORY	TRUE	Ctrl+J	TR4W.INI	Statement
1.14.101	91	FREQUENCY MEMORY ENABLE	NONE	Ctrl+J	TR4W.INI	Statement
1.14.102	92	FREQUENCY POLL RATE	10	Ctrl+J	TR4W.INI	Statement
1.14.103	93	GRID MAP CENTER	NONE	Ctrl+J	TR4W.INI	Statement
1.14.104	94	HAND LOG MODE	FALSE	Ctrl+J	CONTEST.CFG	Statement
1.14.105	95	HF BAND ENABLE	TRUE	Ctrl+J	CONTEST.CFG	Statement
1.14.106	96	HOUR DISPLAY	THIS HOUR	Ctrl+J	TR4W.INI	Statement
1.14.107	97	INCLUDE F-KEY NUMBER	FALSE	Ctrl+J	TR4W.INI	Statement
1.14.108	98	INCREMENT TIME ENABLE	FALSE	Ctrl+J	TR4W.INI	Statement
1.14.109	102	INITIAL EXCHANGE	NONE	Ctrl+J	CONTEST.CFG	Statement
1.14.110	99	INITIAL EXCHANGE CURSOR POS	AT END	Ctrl+J	CONTEST.CFG	Statement
1.14.111	100	INITIAL EXCHANGE FILENAME	INITIAL.EX	Ctrl+J	CONTEST.CFG	Statement
1.14.112	101	INITIAL EXCHANGE OVERWRITE	FALSE	Ctrl+J	CONTEST.CFG	Statement
1.14.113	103	INSERT MODE	TRUE	Ctrl+J	TR4W.INI	Statement
1.14.114	104	INTERCOM FILE ENABLE	FALSE	Ctrl+J	TR4W.INI	Statement
1.14.115	105	KEYER RADIO ONE OUTPUT PORT	NONE	CAT	TR4W.INI	XX
1.14.116	106	KEYER RADIO TWO OUTPUT PORT	NONE	CAT	TR4W.INI	XX
1.14.117	107	KEYPAD CW MEMORIES	FALSE	Ctrl+J	TR4W.INI	Statement
1.14.118	108	LATEST CONFIG FILE	NONE		TR4W.INI	Contest
1.14.119	109	LEADING ZERO CHARACTER	T	Ctrl+J	TR4W.INI	Statement
1.14.120	110	LEADING ZEROS	3	Ctrl+J	CONTEST.CFG	Statement
1.14.121	111	LEAVE CURSOR IN CALL WINDOW	FALSE	Ctrl+J	TR4W.INI	Statement
1.14.122	112	LITERAL DOMESTIC QTH	FALSE	Ctrl+J	CONTEST.CFG	Statement
1.14.123	113	LOG FREQUENCY ENABLE	FALSE	Ctrl+J	TR4W.INI	Statement
1.14.124	114	LOG RS SENT	59	Ctrl+J	TR4W.INI	Statement
1.14.125	115	LOG RST SENT	599	Ctrl+J	TR4W.INI	Statement
1.14.126	116	LOG SUB TITLE	NONE	Ctrl+J	TR4W.INI	Statement
1.14.127	117	LOG WITH SINGLE ENTER	FALSE	Ctrl+J	TR4W.INI	Statement
1.14.128	118	LOOK FOR RST SENT	FALSE	Ctrl+J	TR4W.INI	Statement
1.14.129	119	LPT1 BASE ADDRESS	888	LPT	TR4W.INI	XX
1.14.130	120	LPT2 BASE ADDRESS	632	LPT	TR4W.INI	XX
1.14.131	121	LPT3 BASE ADDRESS	956	LPT	TR4W.INI	XX
1.14.132	122	MAIN CALLSIGN	NONE	Ctrl+J	TR4W.INI	Statement
1.14.133		MAIN FONT	Arial		TR4W.INI	Appearance
1.14.134	123	MESSAGE ENABLE	TRUE	Ctrl+J	TR4W.INI	Statement
1.14.135	124	MINITOUR DURATION	0		TR4W.INI	Contest
1.14.136	125	MISSINGCALLSIGNS FILE ENABLE	FALSE	Ctrl+J	TR4W.INI	Statement
1.14.137	126	MMTTY ENGINE	NONE	Ctrl+J	TR4W.INI	Statement
	127	MODE	CW	Ctrl+J,Alt+M	CONTEST.CFG	XX
1.14.138	128	MP3 PATH	MP3	Ctrl+J	TR4W.INI	Statement
1.14.139	129	MP3 PLAYER	NONE	Ctrl+J	TR4W.INI	Statement
1.14.140	130	MP3 RECORDER BITRATE	16	Ctrl+J	TR4W.INI	Statement
1.14.141	131	MP3 RECORDER DURATION	EACH QSO	Ctrl+J	TR4W.INI	Statement
1.14.142	132	MP3 RECORDER ENABLE	FALSE	Ctrl+J	TR4W.INI	Statement
1.14.143	133	MULT BY BAND	FALSE		TR4W.INI	Contest
1.14.144	134	MULT BY MODE	FALSE		TR4W.INI	Contest
1.14.145	135	MULT REPORT MINIMUM BANDS	4	Ctrl+J	TR4W.INI	Statement
1.14.146	136	MULTI INFO MESSAGE	NONE	Ctrl+J	TR4W.INI	Statement

Definition Section	Ctrl+J #	Configuration Statement	Default value	Hot Key	Stored in	Changed by
1.14.147	137	MULTI MULTS ONLY	FALSE	Ctrl+J	TR4W.INI	Statement
1.14.148	138	MULTIPLE BANDS	TRUE	Ctrl+J	TR4W.INI	Statement
1.14.149	139	MULTIPLE MODES	TRUE	Ctrl+J	TR4W.INI	Statement
1.14.150	140	MY CALL	NONE		TR4W.INI	Contest
1.14.151	141	MY CHECK	NONE	Ctrl+J	TR4W.INI	Statement
1.14.152	142	MY CONTINENT	NONE		TR4W.INI	Contest
1.14.153	143	MY COUNTRY	NONE	Ctrl+J	TR4W.INI	Statement
1.14.154	144	MY FD CLASS	NONE	Ctrl+J	TR4W.INI	Statement
1.14.155	145	MY GRID	NONE	Ctrl+J	TR4W.INI	Statement
1.14.156	146	MY IOTA	NONE	Ctrl+J	TR4W.INI	Statement
1.14.157	147	MY NAME	NONE	Ctrl+J	TR4W.INI	Statement
1.14.158	148	MY POSTAL CODE	NONE	Ctrl+J	TR4W.INI	Statement
1.14.159	149	MY PREC	NONE	Ctrl+J	TR4W.INI	Statement
1.14.160	150	MY QTH	NONE		TR4W.INI	Contest
1.14.161	151	MY SECTION	NONE	Ctrl+J	TR4W.INI	Statement
1.14.162	152	MY STATE	NONE		TR4W.INI	Contest
1.14.163	153	MY ZONE	NONE		TR4W.INI	Contest
1.14.164	154	NAME FLAG ENABLE	TRUE	Ctrl+J	TR4W.INI	Statement
1.14.165	155	NET STATUS UPDATE INTERVAL	5000	Ctrl+J	TR4W.INI	Statement
1.14.166		NO BORDER	FALSE		TR4W.INI	Appearance
1.14.167		NO CAPTION	FALSE		TR4W.INI	Appearance
1.14.168		NO COLUMN HEADER	FALSE		TR4W.INI	Appearance
1.14.169	156	NO LOG	FALSE	Ctrl+J	TR4W.INI	Statement
1.14.170	157	NO POLL DURING PTT	FALSE	Ctrl+J	TR4W.INI	Statement
1.14.171	158	ORION PORT	NONE	Ctrl+J	TR4W.INI	Statement
1.14.172	159	PADDLE MONITOR TONE	700	Ctrl+J	TR4W.INI	Statement
1.14.173	160	PADDLE PORT	NONE	Ctrl+J	TR4W.INI	Statement
1.14.174	161	PADDLE PTT HOLD COUNT	13	Ctrl+J	TR4W.INI	Statement
1.14.175	162	PADDLE SPEED	0	Ctrl+J	TR4W.INI	Statement
1.14.176	163	PARTIAL CALL ENABLE	TRUE	Ctrl+J	TR4W.INI	Statement
1.14.177	164	POLL RADIO ONE	TRUE	Ctrl+J	TR4W.INI	Statement
1.14.178	165	POLL RADIO TWO	TRUE	Ctrl+J	TR4W.INI	Statement
1.14.179	166	POSSIBLE CALL ACCEPT KEY	,	Ctrl+J	TR4W.INI	Statement
1.14.180	167	POSSIBLE CALL LEFT KEY	,	Ctrl+J	TR4W.INI	Statement
1.14.181	168	POSSIBLE CALL MODE	NAMES	Ctrl+J	TR4W.INI	Statement
1.14.182	169	POSSIBLE CALL RIGHT KEY	.	Ctrl+J	TR4W.INI	Statement
1.14.183	170	POSSIBLE CALLS	TRUE	Ctrl+J	TR4W.INI	Statement
1.14.184	171	PREFIX MULTIPLIER	NONE	Ctrl+J	TR4W.INI	Statement
1.14.185	172	PTT ENABLE	TRUE	Ctrl+J	TR4W.INI	Statement
1.14.186	173	PTT LOCKOUT	FALSE	Ctrl+J	TR4W.INI	Statement
1.14.187	174	PTT TURN ON DELAY	15	Ctrl+J	TR4W.INI	Statement
1.14.188	175	PTT VIA COMMANDS	FALSE	Ctrl+J	TR4W.INI	Statement
1.14.189		QSL CW MESSAGE		Alt+P, O	CONTEST.CFG	Function Key
1.14.190		QSL MESSAGE		Alt+P, O	CONTEST.CFG	Function Key
1.14.191	176	QSL MODE	STANDARD	Ctrl+J	TR4W.INI	Statement
1.14.192		QSL SSB MESSAGE		Alt+P, O	CONTEST.CFG	Function Key
1.14.193		QSO BEFORE CW MESSAGE		Alt+P, O	CONTEST.CFG	Function Key
1.14.194		QSO BEFORE MESSAGE		Alt+P, O	CONTEST.CFG	Function Key
1.14.195		QSO BEFORE SSB MESSAGE		Alt+P, O	CONTEST.CFG	Function Key
1.14.196	177	QSO BY BAND	FALSE		TR4W.INI	Contest
1.14.197	178	QSO BY MODE	FALSE		TR4W.INI	Contest
1.14.198	179	QSO NUMBER BY BAND	FALSE	Ctrl+J	TR4W.INI	Statement
1.14.199	180	QSO POINT METHOD	NONE		TR4W.INI	Contest
1.14.200	181	QSO POINTS DOMESTIC CW	-1		TR4W.INI	Contest
1.14.201	182	QSO POINTS DOMESTIC PHONE	-1		TR4W.INI	Contest
1.14.202	183	QSO POINTS DX CW	-1		TR4W.INI	Contest
1.14.203	184	QSO POINTS DX PHONE	-1		TR4W.INI	Contest
1.14.204	185	QSX ENABLE	TRUE	Ctrl+J	TR4W.INI	Statement
1.14.205	186	QTC ENABLE	FALSE	Ctrl+J	TR4W.INI	Statement
1.14.206	187	QTC EXTRA SPACE	TRUE	Ctrl+J	TR4W.INI	Statement
1.14.207	188	QTC MINUTES	FALSE	Ctrl+J	TR4W.INI	Statement

Definition Section	Crtr+J #	Configuration Statement	Default value	Hot Key	Stored in	Changed by
1.14.208	189	QTC QRS	TRUE	Ctrl+J	TR4W.INI	Statement
1.14.209	190	QUESTION MARK CHAR	?	Ctrl+J	TR4W.INI	Statement
1.14.210		QUICK QSL CW MESSAGE		Alt+P, O	CONTEST.CFG	Function Key
1.14.211		QUICK QSL CW MESSAGE1		Alt+P, O	CONTEST.CFG	Function Key
1.14.212	191	QUICK QSL KEY 1		Ctrl+J	TR4W.INI	Statement
1.14.213	192	QUICK QSL KEY 2	=	Ctrl+J	TR4W.INI	Statement
1.14.214		QUICK QSL MESSAGE 1		Alt+P, O	CONTEST.CFG	Function Key
1.14.215		QUICK QSL MESSAGE 2		Alt+P, O	CONTEST.CFG	Function Key
1.14.216		QUICK QSL SSB MESSAGE		Alt+P, O	CONTEST.CFG	Function Key
1.14.217	193	QZB RANDOM OFFSET ENABLE	FALSE	Ctrl+J	TR4W.INI	Statement
1.14.218	194	R150S MODE	FALSE		TR4W.INI	Contest
1.14.219	195	RADIO ONE BAND OUTPUT PORT	NONE	CAT	TR4W.INI	XX
1.14.220		RADIO ONE BAUD RATE	0	CAT	TR4W.INI	XX
1.14.221		RADIO ONE CAT DTR	OFF	CAT	TR4W.INI	XX
1.14.222		RADIO ONE CAT RTS	OFF	CAT	TR4W.INI	XX
1.14.223		RADIO ONE CONTROL PORT	NONE	CAT	TR4W.INI	XX
1.14.224		RADIO ONE FREQUENCY ADDER	0	CAT	TR4W.INI	XX
1.14.225		RADIO ONE FT1000MP CW REVERSE	FALSE	CAT	TR4W.INI	XX
1.14.226		RADIO ONE ICOM FILTER BYTE	2	CAT	TR4W.INI	XX
1.14.227		RADIO ONE KEYSER DTR	CW	CAT	TR4W.INI	XX
1.14.228		RADIO ONE KEYSER RTS	PTT	CAT	TR4W.INI	XX
1.14.229		RADIO ONE NAME	Radio 1	CAT	TR4W.INI	XX
1.14.230		RADIO ONE RECEIVER ADDRESS	0	CAT	TR4W.INI	XX
1.14.231		RADIO ONE TYPE	NONE	CAT	TR4W.INI	XX
1.14.232		RADIO ONE WIDE CW FILTER	FALSE	CAT	TR4W.INI	XX
1.14.233	196	RADIO TWO BAND OUTPUT PORT	NONE	CAT	TR4W.INI	XX
1.14.234	197	RADIO TWO BAUD RATE	0	CAT	TR4W.INI	XX
1.14.235	198	RADIO TWO CAT DTR	OFF	CAT	TR4W.INI	XX
1.14.236	199	RADIO TWO CAT RTS	OFF	CAT	TR4W.INI	XX
1.14.237	200	RADIO TWO CONTROL PORT	NONE	CAT	TR4W.INI	XX
1.14.238	201	RADIO TWO FREQUENCY ADDER	0	CAT	TR4W.INI	XX
1.14.239	202	RADIO TWO FT1000MP CW REVERSE	FALSE	Ctrl+J	TR4W.INI	Statement
1.14.240	203	RADIO TWO ICOM FILTER BYTE	2	Ctrl+J	TR4W.INI	Statement
1.14.241	204	RADIO TWO KEYSER DTR	CW	CAT	TR4W.INI	XX
1.14.242	205	RADIO TWO KEYSER RTS	PTT	CAT	TR4W.INI	XX
1.14.243	206	RADIO TWO NAME	Radio 2	CAT	TR4W.INI	XX
1.14.244	207	RADIO TWO RECEIVER ADDRESS	0	CAT	TR4W.INI	XX
1.14.245	208	RADIO TWO TYPE	NONE	CAT	TR4W.INI	XX
1.14.246	209	RADIO TWO WIDE CW FILTER	FALSE	Ctrl+J	TR4W.INI	Statement
1.14.247	210	RADIUS OF EARTH	0	Ctrl+J	TR4W.INI	Statement
1.14.248	211	RANDOM CQ MODE	FALSE	Ctrl+J	TR4W.INI	Statement
1.14.249	212	RATE DISPLAY	QSOS	Ctrl+J	TR4W.INI	Statement
1.14.250	213	RELAY CONTROL PORT	NONE	Ctrl+J	TR4W.INI	Statement
1.14.251	214	REMAINING MULT DISPLAY MODE	HILIGHT	Ctrl+J	TR4W.INI	Statement
1.14.252	215	REMINDER		??	TR4W.INI	XX
1.14.253		REPEAT S&P CW EXCHANGE		Alt+P, O	Contest.CFG	Function Key
1.14.254		REPEAT S&P EXCHANGE		Alt+P, O	Contest.CFG	Function Key
1.14.255		REPEAT S&P SSB EXCHANGE		Alt+P, O	Contest.CFG	Function Key
1.14.256	216	ROTATOR PORT	NONE	Ctrl+J	TR4W.INI	Statement
1.14.257	217	ROTATOR TYPE	NONE	Ctrl+J	TR4W.INI	Statement
1.14.258		ROW COUNT	5		TR4W.INI	Appearance
1.14.259		S&P CW EXCHANGE		Alt+P, O	CONTEST.CFG	Function Key
1.14.260		S&P EXCHANGE		Alt+P, O	CONTEST.CFG	Function Key
1.14.261		S&P SSB EXCHANGE		Alt+P, O	CONTEST.CFG	Function Key
1.14.262	218	SAY HI ENABLE	FALSE	Ctrl+J	TR4W.INI	Statement
1.14.263	219	SAY HI RATE CUTOFF	200	Ctrl+J	TR4W.INI	Statement
1.14.264	220	SCORE POSTING URL	http://cqcontest.ru/postscore.jsp		TR4W.INI	Contest

Definition Section	Ctrl+J #	Configuration Statement	Default value	Hot Key	Stored in	Changed by
1.14.265	221	SCORE READING URL	http://cqcontest.ru		TR4W.INI	Contest
1.14.266	222	SCP COUNTRY STRING	NONE	Ctrl+J	TR4W.INI	Statement
1.14.267	223	SCP MINIMUM LETTERS	0	Ctrl+J	TR4W.INI	Statement
1.14.268	224	SEND COMPLETE FOUR LETTER CALL	FALSE	Ctrl+J	TR4W.INI	Statement
1.14.269	225	SERIAL PORT DEBUG	FALSE	Ctrl+J	TR4W.INI	Statement
1.14.270	226	SERVER ADDRESS	LOCALHOST	Ctrl+J	TR4W.INI	Statement
1.14.271	227	SERVER PASSWORD	TR4WSERVER	Ctrl+J	TR4W.INI	Statement
1.14.272	228	SERVER PORT	1061	Ctrl+J	TR4W.INI	Statement
1.14.273	229	SHIFT KEY ENABLE	TRUE	Ctrl+J	TR4W.INI	Statement
1.14.274	230	SHORT 0	7	Alt+P, O	TR4W.INI	Function Key
1.14.275	231	SHORT 1	A	Alt+P, O	TR4W.INI	Function Key
1.14.276	232	SHORT 2	2	Alt+P, O	TR4W.INI	Function Key
1.14.277	233	SHORT 9	N	Alt+P, O	TR4W.INI	Function Key
1.14.278	234	SHORT INTEGERS	FALSE	Ctrl+J	CONTEST.CFG	Statement
1.14.279	235	SHOW DOMESTIC MULTIPLIER NAME	FALSE	Ctrl+J	TR4W.INI	Statement
1.14.280	236	SHOW FREQUENCY IN LOG	TRUE	Ctrl+J	TR4W.INI	Statement
1.14.281		SHOW GRIDLINES	FALSE		TR4W.INI	Appearance
1.14.282	237	SHOW TYPED CALLSIGN	TRUE	Ctrl+J	TR4W.INI	Statement
1.14.283	238	SINGLE BAND SCORE	All		CONTEST.CFG	Contest
1.14.284	239	SINGLE RADIO MODE	FALSE	Ctrl+J	TR4W.INI	Statement
1.14.285	240	SKIP ACTIVE BAND	FALSE	Ctrl+J	TR4W.INI	Statement
1.14.286	241	SLASH MARK CHAR	/	Ctrl+J	TR4W.INI	Statement
1.14.287	242	SPACE BAR DUPE CHECK ENABLE	TRUE	Ctrl+J	TR4W.INI	Statement
1.14.288	243	SPRINT QSY RULE	FALSE	Ctrl+J	Contest.CFG	Statement
1.14.289	244	START SENDING NOW KEY	«» (the open-single-quote key, not the apostrophe)	Ctrl+J	TR4W.INI	Statement
1.14.290	245	STATIONS CALLSIGNS MASK	NONE	Ctrl+J	Contest.CFG	Statement
1.14.291	246	STEREO CONTROL PIN	9	Ctrl+J	TR4W.INI	Statement
1.14.292	247	STEREO CONTROL PORT	NONE	Ctrl+J	TR4W.INI	Statement
1.14.293	248	STEREO PIN HIGH	FALSE	Ctrl+J	TR4W.INI	Statement
1.14.294	249	SWAP PACKET SPOT RADIOS	FALSE	Ctrl+J	TR4W.INI	Statement
1.14.295	250	SWAP PADDLES	FALSE	Ctrl+J	TR4W.INI	Statement
1.14.296	251	SWAP RADIO RELAY SENSE	FALSE	Ctrl+J	TR4W.INI	Statement
1.14.297		TAIL END CW MESSAGE		Alt+P, O	CONTEST.CFG	Function Key
1.14.298	252	TAIL END KEY]	Ctrl+J	TR4W.INI	Statement
1.14.299		TAIL END MESSAGE		Alt+P, O	CONTEST.CFG	Function Key
1.14.300		TAIL END SSB MESSAGE		Alt+P, O	TR4W.INI	Function Key
1.14.301	253	TELNET SERVER	sk3w.se:8000	Ctrl+J	TR4W.INI	Statement
1.14.302	254	TEN MINUTE RULE	NONE	Ctrl+J	CONTEST.CFG	Statement
1.14.303	255	TUNE ALT-D ENABLE	FALSE	Ctrl+J	TR4W.INI	Statement
1.14.304	256	TUNE WITH DITS	FALSE	Ctrl+J	TR4W.INI	Statement
1.14.305	257	TWO RADIO MODE	FALSE	Ctrl+J	TR4W.INI	Statement
1.14.306	258	UNKNOWN COUNTRY FILE ENABLE	FALSE	Ctrl+J	TR4W.INI	Statement
1.14.307	259	UNKNOWN COUNTRY FILE NAME	UNKNOWN.CTY	Ctrl+J	TR4W.INI	Statement
1.14.308	260	USE CONTROL PORT	FALSE	Ctrl+J	TR4W.INI	Statement
1.14.309	261	USE RECORDED SIGNS	FALSE	Ctrl+J	TR4W.INI	Statement
1.14.310	262	USER INFO SHOWN	NONE	Ctrl+J	TR4W.INI	Statement
1.14.311	263	VHF BAND ENABLE	FALSE	Ctrl+J	Contest.CFG	Statement
1.14.312	264	WAIT FOR STRENGTH	TRUE	Ctrl+J	TR4W.INI	Statement
1.14.313	265	WAKE UP TIME OUT	0	Ctrl+J	TR4W.INI	Statement
1.14.314	266	WARC BAND ENABLE	FALSE	Ctrl+J	TR4W.INI	Statement
1.14.315	267	WEIGHT	1	Ctrl+J	TR4W.INI	Statement
1.14.316	268	WILDCARD PARTIALS	TRUE	Ctrl+J	TR4W.INI	Statement
1.14.317		WK AUTOSPACE	FALSE	Ctrl+W	TR4W.INI	Winkeyer
1.14.318		WK CT SPACING	FALSE	Ctrl+W	TR4W.INI	Winkeyer
1.14.319		WK DIT DAH RATIO	50	Ctrl+W	TR4W.INI	Winkeyer

Definition Section	Crtr+J #	Configuration Statement	Default value	Hot Key	Stored in	Changed by
1.14.320		WK ENABLE	FALSE	Ctrl+W	TR4W.INI	Winkeyer
1.14.321		WK FIRST EXTENSION	0	Ctrl+W	TR4W.INI	Winkeyer
1.14.322		WK IGNORE SPEED POT	TRUE	Ctrl+W	TR4W.INI	Winkeyer
1.14.323		WK KEYSER COMPENSATION	0	Ctrl+W	TR4W.INI	Winkeyer
1.14.324		WK KEYSER MODE	IAMBIC B	Ctrl+W	TR4W.INI	Winkeyer
1.14.325		WK LEADIN TIME	0	Ctrl+W	TR4W.INI	Winkeyer
1.14.326		WK PADDLE ONLY SIDETONE	FALSE	Ctrl+W	TR4W.INI	Winkeyer
1.14.327		WK PADDLE SWAP	FALSE	Ctrl+W	TR4W.INI	Winkeyer
1.14.328		WK PADDLE SWITCHPOINT	50	Ctrl+W	TR4W.INI	Winkeyer
1.14.329		WK PORT	NONE	Ctrl+W	TR4W.INI	Winkeyer
1.14.330		WK SIDETONE FREQUENCY	800	Ctrl+W	TR4W.INI	Winkeyer
1.14.331		WK SIDETONE ENABLE	TRUE	Ctrl+W	TR4W.INI	Winkeyer
1.14.332		WK TAIL TIME	0	Ctrl+W	TR4W.INI	Winkeyer
1.14.333		WK WEIGHT	50	Ctrl+W	TR4W.INI	Winkeyer
1.14.334		WINDOW SIZE	5		TR4W.INI	Appearance
1.14.335	269	ZONE MULTIPLIER	NONE		TR4W.INI	Contest

1.14 Configuration Statement Definitions

This section contains an alphabetical listing of all the Configuration Statements with a description of how the statement applies. It shows the type of value that is permitted for that statement and the default value for the statement

Each Configuration Statement sets one or more values that are used by TR4W to decide what actions it should take when it detects inputs from the keyboard, the radios, the DX Cluster, network or the computer clock. The default values of Configuration Statements are stored in internal tables and are not available to the user. However, once a Configuration statement is changed by the user and stored with <Alt+W> or <Alt+G>, the Configuration Statement with its new value is written as a one line statement in either the TR4W.INI file or the CONTEST.CFG file

1.14.1 ADD DOMESTIC COUNTRY

Values: String

Default: NONE

Values: Valid country ID. When TR4W is treating some countries as domestic multipliers and the rest of the countries differently, you can add countries to the list of those that are being processed as domestic multipliers. Normally this list is set up by the CONTEST statement, but you can use this command multiple times to add as many countries to the domestic list as you want. You can clear out the default list by using the command ADD DOMESTIC COUNTRY = CLEAR first, and then adding the ones you want. Make sure the country IDs you add match the ones in your CTY.DAT file.

1.14.2 ALL CW MESSAGES CHAINABLE

Values: TRUE or FALSE

Default: FALSE

Normally, when you press a function key memory when a CW message is already playing, the previous message will be aborted and the new message started. However, if you set this flag to TRUE, the new message will not start until the old one is complete. You can also do this for selected CW messages by placing a ctrl-D at the start of the message.

1.14.3 ALLOW AUTO UPDATE

Values: TRUE or FALSE

Default: TRUE

Allow auto rescore of the log in networked mode after QSO edit.

1.14.4 ALT-D BUFFER ENABLE

Values: TRUE or FALSE

Default: FALSE

This command controls whether the alt-D buffer is enabled. When this flag is enabled, TR4W obtains calls and frequencies from the bandmap when performing a dupecheck on the second radio.

1.14.5 ALWAYS CALL BLIND CQ

Values: TRUE or FALSE

Default: FALSE

This function is principally designed to be useful in contests like the Sprint when you are using TR4W with two rigs. In such a situation, you often want to send a CQ on the other rig while you are receiving the exchange from the station to whom you are about to cede the frequency. Normally you do this by pressing F7 or F8, which by default sends CQ on the inactive rig. Setting the ALWAYS CALL BLIND CQ function to TRUE causes that CQ to occur automatically as soon as the CQ EXCHANGE has been sent. (It sends whatever message is stored in Exchange memory F7.). Note that this does force you to be ready for that CQ by finding a clear frequency in time for it to be sent.

1.14.6 ASK FOR FREQUENCIES

Values: TRUE or FALSE

Default: FALSE

When using the bandmap or submitting packet spots in an environment in which you do not have a radio that communicates with TR4W, the program will normally ask you for the frequency of stations as you perform dupe checks. Setting this parameter to FALSE will stop TR4W from asking you for these frequencies.

1.14.7 AUTO CALL TERMINATE

Values: TRUE or FALSE

Default: FALSE

When you are on CW and this parameter is TRUE, TR4W can automatically terminate callsigns that you enter in response to a CQ. When coupled with the START SENDING NOW KEY or the AUTO SEND CHARACTER COUNT commands, TR-LOG will assume that a call is complete when all the characters entered in the Call Window have been transmitted. For example, assume that 4U1ITU has answered your CQ. If you press the key identified by the START SENDING NOW KEY command after entering 4U1I, the program will start to send 4U1I. If you enter one or more additional characters before it completes sending, TR-LOG will send those characters as well. If there are no new characters to send, it will automatically send the CQ EXCHANGE. TR4W works the same way if the AUTO SEND CHARACTER COUNT function causes the program to start sending the callsign. In this case, it is possible to respond to a station by using the same number of keystrokes that are in its callsign.

1.14.8 AUTO DISPLAY DUPE QSO

Values: TRUE or FALSE

Default: FALSE

When you are working a duplicate QSO in CQ Mode and this parameter is TRUE, TR4W will automatically show you the log entries for the previous QSO(s) with that station. This command is nonfunctional if you set AUTO DUPE ENABLE CQ to FALSE.

1.14.9 AUTO DUPE ENABLE CQ

Values: TRUE or FALSE

Default: TRUE

If this parameter is TRUE, a dupe who calls you when you are CQing will be sent the QSO

BEFORE MESSAGE instead of the regular exchange. If the parameter is set to FALSE, the normal exchange will be sent and the TR4W contact will be logged with zero QSO points. It is useful to set this parameter to FALSE when entering a log by hand after a contest.

1.14.10 AUTO DUPE ENABLE S AND P

Values: TRUE or FALSE

Default: TRUE

If this parameter is TRUE, when you try to call a dupe with the key in S&P Mode, TR4W will refuse to call the station. You might want to set this parameter to FALSE in contests like the Internet Sprint, in which you often call the same station on the same band and mode several times during the contest.

1.14.11 AUTO QSL INTERVAL

Values: Integer - 0, 1, 2, 3, 4, 5, 6

Default: 0

Normally when you press to log a QSO, the QSL MESSAGE is transmitted. The AUTO QSL INTERVAL command can be used to send the QUICK QSL MESSAGE instead, except that once every AUTO QSL INTERVAL QSOs, the QSL MESSAGE is transmitted instead. This is typically used when dealing with a large pileup. If you set AUTO QSL INTERVAL to 3, then the QUICK QSL MESSAGE would be sent, except for every third QSO. A value of zero disables this feature, in which case the QSL MESSAGE is sent at the end of every QSO.

1.14.12 AUTO QSO NUMBER DECREMENT

Values: TRUE or FALSE

Default: FALSE

If you have programmed an S&P exchange that includes a QSO number, you might find yourself in the situation in which you have just logged a station who is now asking for a repeat of the exchange you sent him. If you press F2, you will send the next QSO number, which will be one more than the one you sent the first time. To fix this problem, you can set AUTO QSO NUMBER DECREMENT to TRUE; this causes TR4W to decrement the QSO number when you press F2 when both the Call Window and the Exchange Window are empty.

1.14.13 AUTO RETURN TO CQ MODE

Values: TRUE or FALSE

Default: TRUE

If this parameter is TRUE, then pressing in S&P Mode when there is no information in either the Call Window or the Exchange Window will cause TR4W to return to CQ Mode.

1.14.14 AUTO S&P ENABLE

Values: TRUE or FALSE

Default: FALSE

When this parameter is TRUE, TR4W will automatically jump into S&P Mode if it detects you have moved the VFO quickly. See also AUTO S&P SENSITIVITY.

1.14.15 AUTO S&P ENABLE SENSITIVITY

Values: Integer (10 - 10000)

Default: 500

Controls how quickly you must move the VFO (in Hz/sec) in order for the program to jump automatically into S&P Mode if AUTO S&P ENABLE is TRUE.

1.14.16 AUTO SEND CHARACTER COUNT

Values: Integer - 0, 1, 2, 3, 4, 5, 6

Default: 0

TR4W can start to send the callsign of a station responding to your CQ after you have typed a certain number of characters in the callsign of the calling station. This number of characters is controlled with the AUTO SEND CHARACTER COUNT command. For example, if you set

AUTO SEND CHARACTER COUNT to 3 and 4U1ITU calls you, the program will start sending the call after you have typed 4U1. If you enable the AUTO CALL TERMINATE feature, the program will transmit the CQ EXCHANGE message when it has sent all the characters you have typed. When the AUTO SEND CHARACTER COUNT is non-zero, an arrow will appear above the Call Window to indicate the point at which TR4W will begin to transmit the callsign. You can disable this function with the Alt-- command. The arrow will then disappear. To re-enable it, press Alt-- again and the arrow will reappear. You can delete any unsent characters with the backspace key.

1.14.17 AUTO TIME INCREMENT

Values: Integer (0 - 65535)

Default: 0

If you are entering a log by hand, the AUTO TIME INCREMENT feature can be very useful. Setting the value to a non-zero value n will cause the clock to increment by one after every n QSOs. A value of zero disables the feature.

1.14.18 AUTO-CQ DELAY TIME

Values: Integer (500 - 10000)

Default: 3000

1.14.19 BAND

Values: (160, 80, 40, 20, 15, 10, 30, 17, 12, 6, 2, 222, 432, 902, 1GH, 2GH, 3GH, 5GH, 10G, 24G, LGT, All, NON)

Default: 160

You can select the band on which TR4W will start if no contacts have yet been made. After the program is running, use alt-B or alt-V to change band. Some contests are single-band contests and may not let you change bands after a QSO has been made.

1.14.20 BAND MAP ALL BANDS

Values: TRUE or FALSE

Default: FALSE

If TRUE, the bandmap displays entries from all bands. If FALSE, the bandmap displays entries on the current band only. When the cursor is in the bandmap, the value of this flag may be toggled with the B key.

1.14.21 BAND MAP ALL MODES

Values: TRUE or FALSE

Default: FALSE

If TRUE, the bandmap displays entries from all modes. If FALSE, the bandmap displays those entries associated with the current mode only. When the cursor is in the bandmap, the value of this flag may be toggled with the M key.

1.14.22 BAND MAP CALL WINDOW ENABLE

Values: TRUE or FALSE

Default: TRUE

When this is TRUE, and you tune to a frequency that has a station in the bandmap, the callsign and exchange information of the station will be displayed in the Call Window. This allows you to renew the entry by simply pressing the space bar. The exchange information is shown to help you to identify the station quickly. If you start entering a new callsign, the entry in the Call Window will first be erased.

1.14.23 BAND MAP CUTOFF FREQUENCY

Default: 0

Allows you to change, on a band-by-band basis, the frequency below which the mode is assumed to be CW and above which it is assumed to be SSB. When you enter a frequency (in Hz), TR4W will automatically deduce the band for which you are defining a new cutoff frequency. To define new cutoff frequencies for multiple bands, simply include the command as many times as

necessary in your *.CFG file, once per cutoff frequency.

1.14.24 BAND MAP DECAY TIME

Values: Integer (0 - 65535)

Default: 60

This controls the number of minutes for which a new entry will remain visible on the bandmap. The value can be any positive integer less than 32,768. 1Renewing a station with QSX information in this manner will remove the QSX information.

1.14.25 BAND MAP DISPLAY CQ

Values: TRUE or FALSE

Default: TRUE

When FALSE, CQ entries will not appear in the band map.

1.14.26 BAND MAP DUPE DISPLAY

Values: TRUE or FALSE

Default: TRUE

Controls whether the bandmap will include frequencies on which you have called CQ.

1.14.27 BAND MAP ENABLE

Values: TRUE or FALSE

Default: FALSE

Determines whether the bandmap is displayed. See section 6.13 for more information. If you start TR4W with the bandmap disabled, you will have to restart the program for it to be in the correct video mode to display the bandmap.

1.14.28 BAND MAP GUARD BAND

Values: Integer (0 - 65535)

Default: 200

Values: Integer (Hz). The bandmap will indicate if a displayed entry is near the frequency of your interfaced radio by causing the appropriate entry to blink. You can adjust how close the frequency needs to be to the entry for blinking to be triggered.

1.14.29 BAND MAP MULTS ONLY

Values: TRUE or FALSE

Default: FALSE

1.14.30 BAND MAP SPLIT MODE

Values: (BY CUTOFF FREQ, ALWAYS PHONE)

Default: BY CUTOFF FREQ

This parameter allows you to handle properly the mode of stations that are on the bandmap and are operating split. The default value allows you to tailor the CW and PHONE ranges with the BAND MAP CUTOFF FREQUENCY command.

1.14.31 BANDMAP ITEM HEIGHT

Values: Integer (15 - 50)

Default: 17

Height of item in band map window.

1.14.32 BANDMAP ITEM WIDTH

Values: Integer (100 - 200)

Default: 139

Width of item in band map window.

1.14.33 BEEP ENABLE

Values: TRUE or FALSE

Default: TRUE

When set to FALSE, all beeps generated on the PC speaker by TR4W are disabled.

1.14.34 BEEP EVERY 10 QSOS

Values: TRUE or FALSE

Default: FALSE

When set to TRUE, a short beep will be generated every tenth QSO. This is useful when entering a log by hand after the contest to make sure that you haven't skipped any contacts.

1.14.35 BOLD FONT

Values: TRUE or FALSE

Default: TRUE

Set bold font in program windows.

1.14.36 BROADCAST ALL PACKET DATA

Values: TRUE or FALSE

Default: TRUE

When this parameter is set to TRUE and you are using a multi network, all data coming from the TNC are sent to all the computers in the network, where the packet information is viewable with the ctrl-B command. Commands may also be sent from any computer on the network to the TNC. Beware that data are not sent to the TNC until is pressed.

1.14.37 CALL OK NOW CW MESSAGE

Values: String

Default:

1.14.38 CALL OK NOW MESSAGE

Values: String

Default:

1.14.39 CALL OK NOW SSB MESSAGE

Values: String

Default:

1.14.40 CALL WINDOW SHOW ALL SPOTS

Values: TRUE or FALSE

Default: FALSE

When TRUE, as you tune in S&P Mode, all calls that TR4W knows about will appear in the Call Window even if they do not appear in the bandmap. For example, if you have BAND MAP DUPE DISPLAY set to FALSE, dupes will not appear in the bandmap, but they still appear in the Call Window if CALL WINDOW SHOW ALL SPOTS is TRUE.

1.14.41 CALLSIGN UPDATE ENABLE

Values: TRUE or FALSE

Default: FALSE

When this parameter is set to TRUE, TR4W will parse the Exchange Window looking for callsigns; if it finds one, the program will act exactly as if the call had been changed in the Call Window. You must type in the complete call, and spaces must both precede and follow it. If this parameter is TRUE, ctrl-U will send the call in the Exchange Window (otherwise it sends the call in the Call Window).

1.14.42 CATEGORY-ASSISTED

Values: (*NON-ASSISTED, ASSISTED*)

Default: NON-ASSISTED

Used to generate Cabrillo file and for posting score to on-line score systems.

1.14.43 CATEGORY-BAND

Values: (*ALL, 160M, 80M, 40M, 20M, 15M, 10M, 6M, 2M, 222, 432, 902, 1.2G*)

Default: ALL

Used to generate Cabrillo file and for posting score to on-line score systems.

1.14.44 CATEGORY-MODE

Values: (*CW, RTTY, SSB, MIXED*)

Default: CW

Used to generate Cabrillo file and for posting score to on-line score systems.

1.14.45 CATEGORY-OPERATOR

Values: (*SINGLE-OP, MULTI-OP, CHECKLOG*)

Default: SINGLE-OP

Used to generate Cabrillo file and for posting score to on-line score systems.

1.14.46 CATEGORY-POWER

Values: (*HIGH, LOW, QRP*)

Default: HIGH

Used to generate Cabrillo file and for posting score to on-line score systems.

1.14.47 CATEGORY-TRANSMITTER

Values: (*ONE, TWO, LIMITED, UNLIMITED, SWL*)

Default: ONE

Used to generate Cabrillo file and for posting score to on-line score systems.

1.14.48 CHECK LOG FILE SIZE

Values: TRUE or FALSE

Default: FALSE

When TRUE, TR4W will check the size of the log *.trw file to ensure it is the proper size for the number of contacts. This feature can alert you to a disk failure and prevent you from losing too much data. If this error occurs, you should stop the program, back up the files you have to a floppy, run a disk utility to see if you can recover any lost data, and then reboot your computer.

1.14.49 CLEAR DUPE SHEET

Values: TRUE or FALSE

Default: FALSE

Program will clear the dupesheet when this parameter is set to TRUE in a *.CFG file that is executed with the ctrl-V command. TR4W does nothing if the command is found in the *.CFG file during the start-up process.

1.14.50 CODE SPEED

Values: Integer (0 - 99)

Default: 35

Use this command to set the CW speed at which TR4W will start. While the program is running, you can use the alt-S command to set a new speed or use the Page-Up/Page-Down keys to change the code speed in increments of CW SPEED INCREMENT, which is 3 WPM by default. The changes instantly affect any CW being sent.

1.14.51 COLUMN DUPESHEET ENABLE

Values: TRUE or FALSE

Default: FALSE

This parameter controls the format of the visible dupesheet when it is displayed in VGA mode below the normal operating screen. When TRUE, TR4W will place each of the ten numerical call districts in its own column. This makes it easier to find a specific call quickly. If two columns each contain more than 25 calls, the display of the dupesheet reverts to its normal mode.

1.14.52 COMPLETE CALLSIGN MASK

Values: String

Default: NONE

A string defines a mask call, which will be inserted into the input box when you hit function key programmed with the command <03>COMPLETECALL<04>.

1.14.53 COMPUTER ID

Values: Char (A - Z)

Default:

Values: A to Z, or none. When the COMPUTER ID is set to a letter, that letter will be printed just after the QSO number in the log sheet. There is a command in POST that can be used to separate the logs by COMPUTER ID, which can be useful in multi-multi environments.

1.14.54 COMPUTER NAME

Values: String

Default: New

The name of the computer in the TR4W network. The name will be displayed in the window "Network".

1.14.55 CONFIRM EDIT CHANGES

Values: TRUE or FALSE

Default: TRUE

This parameter determines whether you are asked if you want to save the changes made after editing one of your five most recent QSOs (i.e., the QSOs in the editable log) using the alt-E command. Normally, TR4W will ask you whether you want to save changes before updating the LOG.TMP file. To stop TR4W from asking this question, set this parameter to FALSE.

1.14.56 CONNECTION AT STARTUP

Values: TRUE or FALSE

Default: FALSE

If the value is TRUE and if "DX-Cluster" window is opened the program will try to connect to telnet cluster at startup.

1.14.57 CONNECTION COMMAND

Values: String

Default: NONE

Command determines the string that will be sent to telnet DX-cluster at connection.

1.14.58 CONTACTS PER PAGE

Values: Integer (10 - 100)

Default: 50

This controls the number of contacts printed on each page of the log.

1.14.59 CONTEST

Values: *(DUMMY CONTEST, 7QP, ALL-ASIAN-DX-CW, ALL-ASIAN-DX-SSB, ALL JA, AP-SPRINT, ARCI, ARI-DX, ARRL-10, ARRL-160, ARRL-DX-CW, ARRL-DX-SSB, ARRL-SS-CW, ARRL-SS-SSB, ARRL-VHF-QSO, ARRL-VHF-SS, BALTIC, CIS, COUNTY HUNTER, CQ-160-CW, CQ-160-SSB, CALIFORNIA QSO PARTY, CQ-M, CQ-VHF, CQ-WPX-CW, CQ-WPX-SSB, CQ-WPX-RTTY, CQ-WW-CW, CQ-WW-SSB, CROATIAN, RF-CUP-CW, RF-CUP-SSB, RF-CUP-DIG, URAL-CUP, EU-SPRING-CW, EUROPEAN HFC, EUROPEAN VHF, ARRL-FD, FISTS, FCG-FQP, GACW-WWSA-CW, GAGARIN-CUP, GENERAL QSO, GRID LOC, HA DX, HELVETIA, IARU-HF, INTERNET SPRINT, RSGB-IOTA, JIDX-CW, JIDX-SSB, JA LONG PREFECT, MONGOLIAN DX, KCJ, KIDS DAY, KVP, LZ DX, MINITEST, MICHIGAN QSO PARTY, MINNESOTA QSO PARTY, NAQP-CW, NAQP-SSB, NAQP-RTTY, NA-SPRINT-CW, NA-SPRINT-SSB, NA-SPRINT-RTTY, NCCC-SPRINT, NEQP, NRAU-BALTIC-CW, NRAU-BALTIC-SSB, NZ FIELD DAY, OCEANIA-DX-CW, OCEANIA-DX-SSB, OHIO QSO PARTY, OK-OM DX, RADIO-ONY, OZCHR-TEAMS, OZCHR, PACC, QCWA, QCWA GOLDEN, RAC CANADA WINTER, RADIO-VHF-FD, RAEM, RDAC, REGION 1 FIELD DAY, REGION 1 FIELD DAY-RCC-CW, REGION 1 FIELD DAY-RCC-SSB, RF-CHAMP-CW, RF-CHAMP-SSB, AS-CHAMP, RSGB-ROPOCO-CW, RSGB-ROPOCO-SSB, RSGB-160, RDXC, SAC-CW, SAC-SSB, SALMON RUN, SOUTH AMERICAN WW, SP DX, STEW-PERRY, TEN TEN, TEXAS QSO PARTY, TOEC, R4W-CHAMP, UBA-DX-CW, UBA-DX-SSB, UCG, UKRAINE CHAMPIONSHIP, UKRAINIAN, DARC-WAEDC-CW, DARC-WAEDC-SSB, DARC-XMAS, WAG, WISCONSIN QSO PARTY, WWL, WW PMC, XMAS, YO DX, SRR-JR, YUDX, RADIO-160, RADIO-YOC, LOCUST QSO PARTY, ARKTIKA-SPRING, UN DX, NEW YORK QSO PARTY, KING-OF-SPAIN-CW, KING-OF-SPAIN-SSB, WRTC, TENNESSEE QSO PARTY, COLORADO QSO PARTY, R9W-UW9WK-MEMORIAL, TAC, RADIO-MEMORY, DARC-10M, REF-CW, REF-SSB, BLACK SEA CUP, MMAA, CWOPS, OZHCR-VHF, RAC CANADA DAY, CQ-WW-*

RTTY, CWOPEN, MAKROTHEN-RTTY, EU-SPRINT-SPRING-SSB, EU-SPRINT-AUTUMN-CW, EU-SPRINT-AUTUMN-SSB)

Default: DUMMY CONTEST

The CONTEST statement tells TR4W which contest you are going to operate.

1.14.60 CONTEST NAME

Values: String

Default: NONE

This parameter specifies the name of the contest. TR4W adds your call and the year to generate the CONTEST TITLE.

1.14.61 CONTEST TITLE

Values: String

Default: NONE

The CONTEST TITLE is displayed at the top of the screen and in the header of the log pages.

1.14.62 COUNT DOMESTIC COUNTRIES

Values: TRUE or FALSE

Default: FALSE

Setting this parameter to TRUE causes TR4W to include domestic QSOs in the count of DX countries. (This is in addition to any domestic multiplier that the QSO might accrue.)

1.14.63 COUNTRY INFORMATION FILE

Values: String

Default: NONE

This command allows you to specify a file that has up to five lines of text associated with a country (countries are defined by the CTY.DAT file). The text will be displayed in the editable log window when you work the station. The file format consists of the country ID character (as used in the CTY.DAT file) on the first line, followed by up to five lines of text. A blank line indicates the end of the data and can be followed by the next country ID. There is no limit to the file size or to the number of countries.

1.14.64 CQ CW EXCHANGE NAME KNOWN

Values: String

Default:

1.14.65 CQ CW EXCHANGE

Values: String

Default:

1.14.66 CQ EXCHANGE NAME KNOWN

Values: String

Default:

1.14.67 CQ EXCHANGE

Values: String

Default:

1.14.68 CQ SSB EXCHANGE NAME KNOWN

Values: String

Default:

1.14.69 CQ SSB EXCHANGE

Values: String

Default:

1.14.70 CUSTOM CARET

Values: TRUE or FALSE

Default: TRUE

If the value is TRUE in the callsign and exchange windows of the main window will be created

rectangular carriage.

1.14.71 CUSTOM INITIAL EXCHANGE STRING

Values: String

Default: NONE

This string defines how your initial exchange will be constructed if you set INITIAL EXCHANGE to the value CUSTOM. You may select any number of the following fields, and put them in any order: CHECK, CQZONE, FOC, GRID, ITUZONE, NAME, OLDCALL, QTH, SECTION, TENTEN, USER1, USER2, USER3, USER4 and USER5.

1.14.72 CUSTOM USER STRING

Values: String

Default: NONE

This string defines how your user info will be shown if you set USER INFO SHOWN to the value CUSTOM. You may select any number of the following fields, and put them in any order: CHECK, CQZONE, FOC, GRID, ITUZONE, NAME, OLDCALL, QTH, SECTION, TENTEN, USER1, USER2, USER3, USER4 and USER5.

1.14.73 CW ENABLE

Values: TRUE or FALSE

Default: TRUE

When this parameter is FALSE, the computer is prevented from sending any CW, except CW sent from the paddle.

1.14.74 CW SPEED FROM DATABASE

Values: TRUE or FALSE

Default: FALSE

When this parameter is true, TR4W will look in the TRMASTER database for a CW Speed entry for the callsign you are working. If it finds one, it will send the CQ EXCHANGE at that speed. The CW speed will return to the previous value when sending the QSL MESSAGE or a new CQ (if the QSO is aborted).

1.14.75 CW SPEED INCREMENT

Values: Integer - 1, 2, 3, 4, 5, 6, 7, 8, 9, 10, 2

Default: 3

1.14.76 CW TONE

Values: Integer (0 - 65535)

Default: 700

The computer can send the CW over its speaker for the purpose of monitoring the transmission. This command allows you to select the pitch of that CW. Setting the value to zero disables sending the CW to the speaker (but the rig will still be keyed). The PADDLE MONITOR TONE command separately controls the tone frequency of CW sent with the paddle.

1.14.77 DE ENABLE

Values: TRUE or FALSE

Default: TRUE

This determines whether DE is sent before your callsign when using the F1 key in S&P Mode. If you don't want the program to put DE in front of your call (which is the case for most operators), set this flag to FALSE.

1.14.78 DIGITAL MODE ENABLE

Values: TRUE or FALSE

Default: FALSE

When this parameter is TRUE, you can select DIG as a mode when using the alt-M command. DIG is treated as a distinct mode, separate from CW and SSB. This feature is intended to allow you to log digital QSOs made during the ARRL Field Day.

1.14.79 DISTANCE MODE

Values: *(NONE, MILES, KM)*

Default: KM

This parameter controls the display of the distance to the station you are working. The distance is shown along with the beam headings. The value of the distance depends on the value of RADIUS OF EARTH.

1.14.80 DIT DAH RATIO

Values: Integer - 3, 4, 5, 6

Default: 3

Ratio dit/dah in CW.

1.14.81 DOMESTIC FILENAME

Values: Filename

Default: NONE

This command allows you to specify the name of the domestic multiplier file that will be used by the program. This is normally determined by TR4W automatically when you specify a certain contest with the CONTEST parameter. However, if you are creating your own domestic multiplier file and want the program to use yours instead, you can use this command. Make sure you also set the DOMESTIC MULTIPLIER parameter to the value DOMESTIC FILE, so that TR4W will know to look for a file.

1.14.82 DOMESTIC MULTIPLIER

Values: *(NONE, WYSIWYG, IOTA, GRID SQUARES, GRID FIELDS, DOK CODES, DOMESTIC FILE, RDA DISTRICT, NUMERIC ID)*

Default: NONE

This parameter defines which type of domestic multiplier the program will use.

1.14.83 DUPE CHECK SOUND

Values: *(NONE, DUPE BEEP, MULT FANFARE)*

Default: DUPE BEEP

When performing a dupe check with the space bar, TR4W will normally generate a beep if the station is a dupe. However, you can change the program to be silent, or to use the fanfare sound instead.

1.14.84 DUPE SHEET AUTO RESET

Values: TRUE or FALSE

Default: TRUE

When TRUE the program will automatically reset dupe sheet after each tour in multi-tours contests.

1.14.85 DVP ENABLE

Values: TRUE or FALSE

Default: FALSE

This command determines whether the DVP is enabled.

1.14.86 DVP PATH

Default: DVP

1.14.87 DVP RECORDER

Values: Filename

Default: NONE

1.14.88 DX MULTIPLIER

Values: *(NONE, ARRL DXCC WITH NO USA OR CANADA, ARRL DXCC WITH NO ARRL SECTIONS, ARRL DXCC WITH NO USA CANADA KH6 OR KL7, ARRL DXCC WITH NO I OR IS0, ARRL DXCC WITH NO JT, ARRL DXCC, CQ DXCC, CQ DXCC WITH NO USA OR CANADA, CQ DXCC WITH NO HB9, CQ DXCC WITH NO OK, CQ EUROPEAN COUNTRIES, CQ UBA EUROPEAN COUNTRIES, CQ NON EUROPEAN COUNTRIES, NORTH AMERICAN ARRL DXCC WITH NO USA CANADA OR KL7, NON SOUTH AMERICAN COUNTRIES,*

PACC COUNTRIES AND PREFIXES, BLACK SEA COUNTRIES)

Default: NONE

This command determines which type of DX multiplier the program will use.

1.14.89 ESCAPE EXITS SEARCH AND POUNCE

Values: TRUE or FALSE

Default: TRUE

When this parameter is TRUE, pressing when in S&P Mode causes TR4W to revert to CQ Mode.

When the parameter is FALSE, the only way to revert to CQ Mode is to press shift-Tab.

However, the FALSE setting is ignored if you have a call ready for a QSO on the other rig. This allows you to abort a second-radio QSO with even if this parameter is FALSE.

1.14.90 EXCHANGE MEMORY ENABLE

Values: TRUE or FALSE

Default: TRUE

This parameter allows you to control whether the TR4W exchange memory is used. The exchange memory is useful when working the same station on different bands or modes, and when the exchange contains either a class (e.g., ARRL Field Day), power (ARRL DX), age (All Asian), name, ITU Society name (IARU), zone, or Domestic QTH. If you have worked the station before in the contest, the constant information will appear without you having to re-enter it. Please note that this information is lost if you stop TR4W and the *.RST file is deleted.

1.14.91 EXCHANGE RECEIVED

Values: *(UNKNOWN, NONE, QSO NUMBER AND AGE, CHECK AND CHAPTER OR QTH EXCHANGE, CLASS DOMESTIC OR DX QTH, KIDS DAY EXCHANGE, NAME DOMESTIC OR DX QTH, NAME QTH AND POSSIBLE TEN TEN NUMBER, NAME AND POSSIBLE GRID SQUARE, NZ FIELD DAY, GRID, QSO NUMBER AND PREVIOUS QSO NUMBER, QSO NUMBER AND GEO COORDINATES, QSO NUMBER AND COORDINATES SUM, QSO NUMBER AND ZONE, QSO NUMBER AND NAME, QSO NUMBER AND GRID, QSO NUMBER AND POSSIBLE DOMESTIC QTH, QSO NUMBER DOMESTIC OR DX QTH, QSO NUMBER DOMESTIC QTH, QSO NUMBER NAME CHAPTER AND QTH, QSO NUMBER NAME DOMESTIC OR DX QTH, QSO NUMBER PRECEDENCE CHECK SECTION, RST AGE, RST ALL JA PREFECTURE AND PRECEDENCE, RST AND CONTINENT, RST AND GRID, RST AND OR GRID, RST QSO NUMBER OR DOMESTIC QTH, RST AND POSTAL CODE, RST DOMESTIC OR DX QTH, RST DOMESTIC QTH, RST DOMESTIC QTH OR QSO NUMBER, RST NAME QTH, RST POSSIBLE DOMESTIC QTH AND POWER, RST POWER, RST PREFECTURE, RST QSO NUMBER AND DOMESTIC QTH, RST QSO NUMBER AND GRID SQUARE, RST QSO NUMBER AND POSSIBLE DOMESTIC QTH, RST QSO NUMBER AND RANDOM CHARACTERS, RST QTH NAME AND FISTS NUMBER OR POWER, RST QSO NUMBER, RST QTH, RST ZONE AND POSSIBLE DOMESTIC QTH, RST ZONE, RST ZONE OR SOCIETY, RST LONG JA PREFECTURE, RST AGE AND POSSIBLE SK, RST ZONE OR DOMESTIC QTH, RST AND QSO NUMBER OR FRENCH DEPARTMENT)*

Default: UNKNOWN

This parameter tells TR4W what kind of exchange data to expect. It is normally controlled by the CONTEST statement in the *.CFG file.

1.14.92 FARNSWORTH ENABLE

Values: TRUE or FALSE

Default: FALSE

When slowing down the CW speed, it is often desirable to increase the space between letters.

Turning on FARNSWORTH ENABLE will increase the spaces between letters exponentially as your speed decreases below the value of FARNSWORTH SPEED (default is 25 WPM). You can control this parameter dynamically while sending a CW message.

1.14.93 FARNSWORTH SPEED

Values: Integer (0 - 99)

Default: 25

Values: Integer (WPM). Controls the CW speed at which the Farnsworth effect starts. As you decrease the code speed below this value, there will be exponentially more space added between characters. For increased Farnsworth effect at very slow speeds, increase the value of FARNSWORTH SPEED. You can also control this parameter dynamically within CW messages.

1.14.94 FLOPPY FILE SAVE FREQUENCY

Values: Integer (0 - 65535)

Default: 0

Values: Integer (# of contacts). This command allows you to control how frequently TR4W saves the current log to another file. A value of 0 (which is the default) disables this feature.

1.14.95 FLOPPY FILE SAVE NAME

Values: Filename

Default: C:\LOGBACK.TRW

This command allows you to backup the *.TRW file periodically throughout the contest to another disk drive. To enable this feature, set the FLOPPY FILE SAVE FREQUENCY equal to the number of contacts you wish to make between backups. The name of the file to which the backup will be made is controlled by the FLOPPY FILE SAVE NAME command. The names of these commands are misleading: you can make backups to any drive; you can even make backups to the current working directory as long as the name of the backup file is something different from *.TRW.

1.14.96 FOOT SWITCH MODE

Values: (DISABLED, CW GRANT, F1, LAST CQ FREQ, NEXT BANDMAP, NEXT DISP BANDMAP, NEXT MULT BANDMAP, NEXT MULT DISP BANDMAP, UPDATE BAND MAP BLINKING CALL, DUPE CHECK, NORMAL, QSO NORMAL, QSO QUICK, CONTROL ENTER, START SENDING, SWAP RADIOS)

Default: DISABLED

This command determines what happens when you press a foot switch that is connected to pin 15 of the port specified by the FOOT SWITCH PORT command.

1.14.97 FOOT SWITCH PORT

Values: 1, 2, 3 or NONE

Default: NONE

1.14.98 FREQUENCY ADDER RADIO ONE

Values: Integer (0 - 2147483647)

Default: 0

1.14.99 FREQUENCY ADDER RADIO TWO

Values: Integer (0 - 2147483647)

Default: 0

1.14.100 FREQUENCY MEMORY

Values: Frequency (kHz).

Default: NONE

When TR4W first switches to a band/mode, it has a frequency that it will go to as a default. Use this command if you would like to change the default value. Use this command once per band that you would like to change. If you are specifying a frequency that might be processed as a CW frequency but which you want to be used as an SSB frequency, put SSB in front of it (e.g.:FREQUENCY MEMORY = SSB 7050). Note that these defaults will be updated with actual frequencies used for later band/mode changes if you set FREQUENCY MEMORY ENABLE to TRUE.

1.14.101 FREQUENCY MEMORY ENABLE

Values: TRUE or FALSE

Default: TRUE

When set to TRUE, this parameter will enable the frequency memory. This means that you will return to the frequency you were last using when returning to a band (even with the other radio).

1.14.102 FREQUENCY POLL RATE

Values: Integer (10 - 1000)

Default: 10

Values: Integer 10 to 1000 (msec). This command tells TR4W how frequently to poll the rig for a new frequency. The value is in milliseconds, and the allowed values are in the range 10 to 1000.

1.14.103 GRID MAP CENTER

Values: String

Default: NONE

Values: Four- or six-character grid reference. This parameter will set the centre of a grid map that will show you at a glance the grids you have worked. The grid map will be displayed in VGA mode (if available). The ctrl-Left and ctrl-Right keys may be used to move the grid map sideways. (There is no way to move the grid map vertically.)

1.14.104 HAND LOG MODE

Values: TRUE or FALSE

Default: FALSE

1.14.105 HF BAND ENABLE

Values: TRUE or FALSE

Default: TRUE

This parameter enables the HF bands below 30 MHz. It is automatically set to FALSE when you select a VHF contest.

1.14.106 HOUR DISPLAY

Values: (*THIS HOUR, LAST SIXTY MINUTES, BAND CHANGES, BAND CHANGES ON THIS COMPUTER*)

Default: THIS HOUR

Values: THIS HOUR, LAST SIXTY MINUTES or BAND CHANGES. This parameter determines how the hour rate display works. In the THIS HOUR mode, it shows the number of QSOs made during the current hour (starting at 15:00, for example). In the LAST SIXTY MINUTES, it shows the number of contacts made during the last 60 minutes. The BAND CHANGES mode will count how many band changes have been made since the current hour began.

1.14.107 INCLUDE F-KEY NUMBER

Values: TRUE or FALSE

Default: FALSE

1.14.108 INCREMENT TIME ENABLE

Values: TRUE or FALSE

Default: FALSE

Determines whether the "increment time function" using Alt-1 to Alt-0 is enabled. If this flag is set to TRUE, the alt-1 to alt-0 keys will increment the time by 1 to 10 minutes respectively. This function can be useful when entering a log by hand after the contest.

1.14.109 INITIAL EXCHANGE

Values: (*NONE, NAME, NAME QTH, CHECK SECTION, SECTION, QTH, FOC NUMBER, GRID, ZONE, USER 1, USER 2, USER 3, USER 4, USER 5, CUSTOM*)

Default: NONE

This parameter controls the generation of an initial exchange based upon the callsign. All information except the zone must come from the TRMASTER.DTA database. The zone may come from the database, or if not found there, will be calculated based upon the callsign and the information found in the CTY.DAT country file. If this parameter is set to CUSTOM, your initial

exchange will be built using the CUSTOM INITIAL EXCHANGE STRING parameter. This allows you to choose multiple data fields and place them in any order. You can program initial exchanges using the file specified by the INITIAL EXCHANGE FILENAME parameter. Initial exchanges can also come from the initial exchange memory if you have already worked the station once in the contest.

1.14.110 INITIAL EXCHANGE CURSOR POS

Values: AT START or AT END.

Default: AT END

When an initial exchange is inserted into the Exchange Window, this command controls whether the cursor is placed at the start or at the end of the exchange.

1.14.111 INITIAL EXCHANGE FILENAME

Values: Filename

Default: INITIAL.EX

This parameter allows you to specify the name of the initial exchange file. This file is used by TR4W to determine initial exchanges for the callsigns included in the file. The calls will also be used in the partial call list. The format for the file is: callsign, followed by a space, and then the initial exchange information as you want it to appear in the Exchange Window.

1.14.112 INITIAL EXCHANGE OVERWRITE

Values: TRUE or FALSE

Default: FALSE

If this parameter is TRUE, then pressing any key after an initial exchange has been entered into the Exchange Window by TR4W will cause the exchange to be erased, allowing you to insert a complete exchange manually.

1.14.113 INSERT MODE

Values: TRUE or FALSE

Default: TRUE

This command allows you to define the initial state of the insert mode, which controls whether characters are overwritten or inserted when editing a callsign or exchange. You can toggle the insert mode while TR4W is running with ctrl-V or the INSERT key.

1.14.114 INTERCOM FILE ENABLE

Values: TRUE or FALSE

Default: FALSE

When this parameter is TRUE, all messages sent between computers during the contest will be logged to the file INTERCOM.TXT.

1.14.115 KEYER RADIO ONE OUTPUT PORT

Values: (NONE, SERIAL 1, SERIAL 2, SERIAL 3, SERIAL 4, SERIAL 5, SERIAL 6, SERIAL 7, SERIAL 8, SERIAL 9, SERIAL 10, SERIAL 11, SERIAL 12, SERIAL 13, SERIAL 14, SERIAL 15, SERIAL 16, SERIAL 17, SERIAL 18, SERIAL 19, SERIAL 20, PARALLEL 1, PARALLEL 2, PARALLEL 3)

Default: NONE

These commands select which computer port is used for the CW and PTT outputs. You may specify serial ports in the range 1 to 4, and parallel ports in the range 1 to 3. When specifying a serial port for CPU keying, you can add the word INVERT to the port name (e.g., SERIAL 1 INVERT). This will invert the CW and PTT signals. This simplifies the interface to a radio which uses inverted signalling. Replace the NPN transistors shown in Appendix B with PNP transistors. Use clamp diodes to prevent the base from going positive.

1.14.116 KEYER RADIO TWO OUTPUT PORT

Values: (NONE, SERIAL 1, SERIAL 2, SERIAL 3, SERIAL 4, SERIAL 5, SERIAL 6, SERIAL 7, SERIAL 8, SERIAL 9, SERIAL 10, SERIAL 11, SERIAL 12, SERIAL 13, SERIAL 14, SERIAL 15,

SERIAL 16, SERIAL 17, SERIAL 18, SERIAL 19, SERIAL 20, PARALLEL 1, PARALLEL 2, PARALLEL 3)

Default: NONE

These commands select which computer port is used for the CW and PTT outputs. You may specify serial ports in the range 1 to 4, and parallel ports in the range 1 to 3. When specifying a serial port for CPU keying, you can add the word INVERT to the port name (e.g., SERIAL 1 INVERT). This will invert the CW and PTT signals. This simplifies the interface to a radio which uses inverted signalling. Replace the NPN transistors shown in Appendix B with PNP transistors. Use clamp diodes to prevent the base from going positive.

1.14.117 KEYPAD CW MEMORIES

Values: TRUE or FALSE

Default: FALSE

When this parameter is TRUE, the keys 0 to 9 on the keypad will send CQ MEMORIES ctrl-F1 to ctrl-F10 respectively.

1.14.118 LATEST CONFIG FILE

Values: Filename

Default: NONE

1.14.119 LEADING ZERO CHARACTER

Values: Char

Default: T

This parameter allows you to customize the character used as a leading zero when generating serial numbers and LEADING ZEROS has a value greater than zero. Normally, the character is T. However, you might prefer the number 0 or the letter O. If you use the ctrl-J menu to access this parameter, it will let you cycle among those three characters.

1.14.120 LEADING ZEROS

Values: Integer - 0, 1, 2, 3

Default: 3

If you want your serial number to be a certain length by adding leading zeros, you can specify the length with this command. A value of zero disables the addition of any leading zeros. You can set the character used for leading zeros with the LEADING ZERO CHARACTER command.

1.14.121 LEAVE CURSOR IN CALL WINDOW

Values: TRUE or FALSE

Default: FALSE

When this parameter is TRUE, the cursor will remain in the Call Window instead of moving automatically to the Exchange Window during the QSO process. Some people prefer this mode in contests where a zone is displayed as the initial exchange and you rarely need to change it.

1.14.122 LITERAL DOMESTIC QTH

Values: TRUE or FALSE

Default: FALSE

Normally, TR4W will filter the domestic QTH that you type, and log the QTH as shown in the domestic file. If you would rather log exactly what you type, set this parameter to TRUE.

1.14.123 LOG FREQUENCY ENABLE

Values: TRUE or FALSE

Default: FALSE

When this parameter is TRUE, the serial number will be replaced with the frequency of the QSO (without the leading Megahertz part of the value). The band and mode will still be written at the start of the log entry. This feature is only useful if you have an interfaced radio.

1.14.124 LOG RS SENT

Values: Integer (11 - 59)

Default: 59

The outbound signal report that appears in your log can be changed from the default of 59 or 599. Note that the [character in your CW exchange allows you to enter the strength of the RST transmitted, and this value will be placed in your log instead of the default.

1.14.125 LOG RST SENT

Values: Integer (111 - 599)

Default: 599

The outbound signal report that appears in your log can be changed from the default of 59 or 599. Note that the [character in your CW exchange allows you to enter the strength of the RST transmitted, and this value will be placed in your log instead of the default.

1.14.126 LOG SUB TITLE

Values: String

Default: NONE

Use this command if you want a subtitle to appear at the top of each printed log page.

1.14.127 LOG WITH SINGLE ENTER

Values: TRUE or FALSE

Default: FALSE

If this parameter is TRUE, the QSO will be logged as soon as you press the initial (to send the exchange). In other words, it behaves as if you have pressed followed by ctrl-Enter.

1.14.128 LOOK FOR RST SENT

Values: TRUE or FALSE

Default: FALSE

When this parameter is TRUE, a transmitted RST may be entered into the Exchange Window by preceding it with S. For example, typing S57 would place S57 into the log as the transmitted exchange for this QSO.

1.14.129 LPT1 BASE ADDRESS

Values: Integer (0 - 65535)

Default: 888

The base address of parallel port LPT1 (PARALLEL 1).

1.14.130 LPT2 BASE ADDRESS

Values: Integer (0 - 65535)

Default: 632

The base address of parallel port LPT2 (PARALLEL 2).

1.14.131 LPT3 BASE ADDRESS

Values: Integer (0 - 65535)

Default: 956

The base address of parallel port LPT3 (PARALLEL 3).

1.14.132 MAIN CALLSIGN

Values: String

Default: NONE

1.14.133 MAIN FONT

Values: String

Default: Arial

The command specifies the name of the font to be used when displaying the information in the main program window.

1.14.134 MESSAGE ENABLE

Values: TRUE or FALSE

Default: TRUE

This command determines whether the various messages located in the alt-P menu are sent. If you disable them by setting this parameter to FALSE, messages such as the CQ EXCHANGE and QSL MESSAGE will not be sent. This command would be used if you want to send these

messages manually.

1.14.135 MINITOUR DURATION

Values: Integer (5 - 60)

Default: 0

Value: integer from 5 to 60. Specifies in minutes tour duration in multi-tours contests.

1.14.136 MISSINGCALLSIGNS FILE ENABLE

Values: TRUE or FALSE

Default: FALSE

1.14.137 MMTTY ENGINE

Values: Filename

Default: NONE

MODE

Values: (*CW*, *DIG*, *SSB*, *BTH*, *NON*, *FM*)

Default: CW

You can use this command to select the mode in which TR4W will start when no QSOs have been made. Normally, you would just use alt-M to select the desired mode.

1.14.138 MP3 PATH

Default: MP3

The directory where the MP3 files will be saved. By default this is [tr4w_directory][contest_directory][mp3] folder.

1.14.139 MP3 PLAYER

Values: Filename

Default: NONE

Player to be used for MP3 files playback.

1.14.140 MP3 RECORDER BITRATE

Values: Integer - 8, 16, 24, 32, 40, 48, 56, 64

Default: 16

MP3 recorder bitrate.

1.14.141 MP3 RECORDER DURATION

Values: (*EACH QSO*, *EACH HOUR*, *NON-STOP*)

Default: EACH QSO

1.14.142 MP3 RECORDER ENABLE

Values: TRUE or FALSE

Default: FALSE

If the value is TRUE MP3 recording starts immediately after opening the "MP3 Recorder" window.

1.14.143 MULT BY BAND

Values: TRUE or FALSE

Default: FALSE

These commands determine whether multipliers can be counted again on different bands or modes. These parameters are configured when the CONTEST statement is executed and normally do not require any changes.

1.14.144 MULT BY MODE

Values: TRUE or FALSE

Default: FALSE

These commands determine whether multipliers can be counted again on different bands or modes. These parameters are configured when the CONTEST statement is executed and normally

do not require any changes.

1.14.145 MULT REPORT MINIMUM BANDS

Values: Integer - 2, 3, 4

Default: 4

Values: Integer in range 2 to 4. These commands are synonymous. When executing the ctrl-O command, you will be shown DX multipliers that you have worked on a certain number, but not all, bands. This parameter sets the minimum number of bands on which the country must have been worked in order to appear on this report.

1.14.146 MULTI INFO MESSAGE

Values: String

Default: NONE

If you are using a computer network for a multi operation, this command will determine whether all QSOs are passed around the network, or only those that are new multipliers.

1.14.147 MULTI MULTS ONLY

Values: TRUE or FALSE

Default: FALSE

If you are using a computer network for a multi operation, this command will determine whether all QSOs are passed around the network, or only those that are new multipliers.

1.14.148 MULTIPLE BANDS

Values: TRUE or FALSE

Default: TRUE

These commands control the ability to change bands or modes while working the contest. If you are working a single mode or single band contest, it is recommended that the corresponding flag be set to FALSE. This will prevent you from changing band or mode accidentally during the contest. Before you make your first QSO, you will be able to set the band and mode regardless of the value of these parameters.

1.14.149 MULTIPLE MODES

Values: TRUE or FALSE

Default: TRUE

These commands control the ability to change bands or modes while working the contest. If you are working a single mode or single band contest, it is recommended that the corresponding flag be set to FALSE. This will prevent you from changing band or mode accidentally during the contest. Before you make your first QSO, you will be able to set the band and mode regardless of the value of these parameters.

1.14.150 MY CALL

Values: String

Default: NONE

Values: Your callsign. This must be the first statement of your *.CFG file. You should include any portable designation. The ctrl-J menu allows you to view the value of MY CALL, but not to edit it.

1.14.151 MY CHECK

Values: String

Default: NONE

Values: Any string. This command is mandatory when operating the Sweepstakes contest. If CONTEST is set to SWEEPSTAKES, TR4W will prompt you for this value if it is not already set.

1.14.152 MY CONTINENT

Values: (NONE, NA, SA, EU, AF, AS, OC)

Default: NONE

Values: AF, AS, EU, NA, OC or SA. Normally, your continent is determined by your callsign.

However, if you want the program to place you in a different continent, use this command. It is best to put this command before the CONTEST statement in your *.CFG file so that TR4W can configure the contest correctly. The ctrl-J menu allows you to view the value of MY CONTINENT, but not to edit it.

1.14.153 MY COUNTRY

Values: String

Default: NONE

Values: Any valid country ID. Normally, your country is determined by your callsign. However, if you want the program to place you in a different country, use this command. It is best to put this command before the CONTEST statement in your *.CFG file so that TR4W can configure the contest correctly. The ctrl-J menu allows you to view the value of MY COUNTRY, but not to edit it.

1.14.154 MY FD CLASS

Values: String

Default: NONE

Values: Any valid ARRL Field Day class. This is used to set your station class for ARRL Field Day (e.g., 1A). If you are operating the Field Day, TR4W will prompt you for this value if it is not already set

1.14.155 MY GRID

Values: String

Default: NONE

Values: Four- or six-character grid identifier. This parameter identifies the grid from which you are operating. This is used to generate beam heading from your location. It is also used to determine QSO points when using a QSO point method that computes points based upon distance. Use GRID MAP CENTER to set separately the center of the grid map.

1.14.156 MY IOTA

Values: String

Default: NONE

Values: IOTA designator. This is used to set the IOTA identifier of the island from which you are operating (e.g., EU-006).

1.14.157 MY NAME

Values: String

Default: NONE

Values: Any string. Use this command before the CONTEST statement if you are operating a contest that uses your name as part of the exchange. In contests where the exchange includes the name received in the prior QSO (using the special CW character ()), TR4W will use this value as the name that is sent in the first QSO.

1.14.158 MY POSTAL CODE

Values: String

Default: NONE

Values: Any string. Used in the RSGB ROPOCO (Rotating Post Code) contest as the postcode sent in the first QSO.

1.14.159 MY PREC

Values: String

Default: NONE

Values: A, B, M, Q, S or U. This command is mandatory when operating Sweepstakes. If you are operating Sweepstakes, TR4W will prompt you for this value if it is not already set.

1.14.160 MY QTH

Values: String

Default: NONE

Values: Any string. This is a synonym for MY STATE.

1.14.161 MY SECTION

Values: String

Default: NONE

Values: Any string. This is mandatory when operating Sweepstakes or ARRL Field Day. If your chosen contest requires this information, TR4W will prompt you for this value if it is not already set.

1.14.162 MY STATE

Values: String

Default: NONE

Values: Any string. In some of the contests where a state or province is part of the exchange, TR4W will automatically configure the CW messages to include your location. This command allows you to tell the program what state (or province) to use in these messages. This command is also used to determine your state for various state QSO parties. Use the ordinary United States Postal Service two-letter state abbreviation to set your state. It is best to put this command before the CONTEST statement in your *.CFG file so that the information is processed correctly.

1.14.163 MY ZONE

Values: String

Default: NONE

Values: Integer Normally, your zone is determined by your callsign. However, if you want TR4W to place you in a different zone, use this command. It is best to put this command before the CONTEST statement in your *.CFG file, so that TR4W will configure the contest properly. However, the relationship between what happens when the contest executes the MY ZONE command and when it executes the CONTEST command is complex, and under some circumstances (for example, the IARU contest) the MY ZONE command should appear after the CONTEST command. The most common symptom of having these commands in the incorrect order is that TR4W will score the contest as if you were in a different zone from the one in which you are actually located. If you see that TR4W does not seem to be scoring the contest properly, you should try switching

1.14.164 NAME FLAG ENABLE

Values: TRUE or FALSE

Default: TRUE

When this parameter is TRUE, an asterisk is shown in the log when you make a QSO with a station whose name is known.

1.14.165 NET STATUS UPDATE INTERVAL

Values: Integer (1000 - 10000)

Default: 5000

1.14.166 NO BORDER

Values: TRUE or FALSE

Default: FALSE

1.14.167 NO CAPTION

Values: TRUE or FALSE

Default: FALSE

If the value is TRUE after startup all windows except the main will not have a title.

1.14.168 NO COLUMN HEADER

Values: TRUE or FALSE

Default: FALSE

1.14.169 NO LOG

Values: TRUE or FALSE

Default: FALSE

If you want to disable a computer on the network from logging any QSOs, set this parameter to TRUE.

1.14.170 NO POLL DURING PTT

Values: TRUE or FALSE

Default: FALSE

When this parameter is TRUE, TR4W will not poll the radio for frequency information during the time the PTT signal is active.

1.14.171 ORION PORT

Values: (*NONE, SERIAL 1, SERIAL 2, SERIAL 3, SERIAL 4, SERIAL 5, SERIAL 6, SERIAL 7, SERIAL 8, SERIAL 9, SERIAL 10, SERIAL 11, SERIAL 12, SERIAL 13, SERIAL 14, SERIAL 15, SERIAL 16, SERIAL 17, SERIAL 18, SERIAL 19, SERIAL 20, PARALLEL 1, PARALLEL 2, PARALLEL 3*)

Default: NONE

This command is used to select a serial port on which to communicate with an Orion rotator control. To send the rotator to the direction for the country of a callsign in the Call Window, use the ctrl-P command Rotator control.

1.14.172 PADDLE MONITOR TONE

Values: Integer (0 - 65535)

Default: 700

The computer speaker monitor is normally used when you send with a paddle connected to the parallel port. This command controls the frequency of the generated sidetone. A value of zero disables the tone.

1.14.173 PADDLE PORT

Values: 1, 2, 3 or NONE

Default: NONE

1.14.174 PADDLE PTT HOLD COUNT

Values: Integer (0 - 65535)

Default: 13

This command controls the delay between when you stop sending CW with the paddle and when the PTT is released. The delay is measured in dit counts.

1.14.175 PADDLE SPEED

Values: Integer (0 - 99)

Default: 0

This command Controls the speed of CW sent with the paddle. A value of zero causes the paddle to send at the same speed as TR4W.

1.14.176 PARTIAL CALL ENABLE

Values: TRUE or FALSE

Default: TRUE

This command allows you to control the partial call function. This is a separate feature from the super check partial (which uses the TRMASTER.DTA database). The callsigns used by the partial call function come from the dupesheet and initial exchange file. When this function is enabled, partial calls will be shown on the bottom of the screen after the second character of a call has been typed into the Call Window. A "partial call" is defined to be any call that starts with the same letters as those in the Call Window. The WILDCARD PARTIALS parameter determines whether the partial call must appear at the start of

1.14.177 POLL RADIO ONE

Values: TRUE or FALSE

Default: TRUE

1.14.178 POLL RADIO TWO

Values: TRUE or FALSE

Default: TRUE

1.14.179 POSSIBLE CALL ACCEPT KEY

Values: Char

Default: ;

Values: Any character.

1.14.180 POSSIBLE CALL LEFT KEY

Values: Char

Default: ,

Values: Any character.

1.14.181 POSSIBLE CALL MODE

Values: (*ALL, NAMES, LOG ONLY*)

Default: NAMES

Values: NAMES or ALL. The possible calls that come from the TRMASTER.DTA file can either come from all of the calls or only those with names associated with them. When set to NAMES, the operation is identical to older versions of TR4W which used the name database for possible calls.

1.14.182 POSSIBLE CALL RIGHT KEY

Values: Char

Default: .

Values: Any character. When you are using the PARTIAL CALL ENABLE or the POSSIBLE CALLS feature, you are shown a list of calls in the bottom of the operating screen. The first call shown will have a cursor around it (like this: `.`). You can transfer the callsign with the cursor around it to the Call Window with the POSSIBLE CALL ACCEPT KEY. You can move the cursor to the left and the right with the POSSIBLE CALL LEFT KEY and the POSSIBLE CALL RIGHT KEY.

1.14.183 POSSIBLE CALLS

Values: TRUE or FALSE

Default: TRUE

When this parameter is TRUE, the possible call feature is enabled. This causes TR4W to display similar calls from the TRMASTER.DTA database and from your dupesheet when you are working a new station.

1.14.184 PREFIX MULTIPLIER

Values: (*NONE, ASIAN PREFIXES, BELGIUM PREFIXES, CALLSIGN, MONGOLIAN CALLSIGN PREFIX, NON SOUTH AMERICAN PREFIXES, NORTH AMERICAN PREFIXES, PREFIX, SAC DISTRICTS, SOUTH AMERICAN PREFIXES, SOUTH AND NORTH AMERICAN PREFIXES, YU PREFIXES, GC STATION, CQ NON EUROPEAN COUNTRIES AND WAE*)

Default: NONE

Values: NONE or PREFIX. This command instructs TR4W how to handle the prefix multiplier. It is normally set by the CONTEST statement in the file *.CFG.

1.14.185 PTT ENABLE

Values: TRUE or FALSE

Default: TRUE

This command controls whether the PTT signal is active. The PTT signal is intended to be used to turn on your transmitter just before a CW message starts and to turn it off as soon as the message being sent has concluded. If you are using break-in (QSK), you should disable this signal.

1.14.186 PTT LOCKOUT

Values: TRUE or FALSE

Default: FALSE

Command determines whether or not to use the PTT lockout in networked mode.

1.14.187 PTT TURN ON DELAY

Values: Integer (0 - 65535)

Default: 15

This parameter controls the amount of time that elapses between the assertion of the PTT signal and the start of the first transmitted CW character. The value is multiplied by 1.7 milliseconds. A value of zero disables the feature.

1.14.188 PTT VIA COMMANDS

Values: TRUE or FALSE

Default: FALSE

Send PTT command to rig via CAT interface.

1.14.189 QSL CW MESSAGE

Values: String

Default:

1.14.190 QSL MESSAGE

Values: String

Default:

1.14.191 QSL MODE

Values: (*NONE, STANDARD, QSL BUT DO NOT LOG, QSL AND LOG*)

Default: STANDARD

Values: STANDARD, QSL AND LOG, or QSL BUT NO LOG. This command can be used to change the criteria used to QSL an exchange and to log it when you are in CQ Mode. Normally, TR4W requires the complete exchange to be entered before you can QSL and log the contact. However, if you select QSL BUT NO LOG, the QSL message will be sent even if the exchange information is not completed, but you need to finish entering the exchange and hit again before it will be logged. QSL AND LOG will totally eliminate any syntax checking on the exchange and log whatever you have entered. This mode is NOT recommended in normal operations.

1.14.192 QSL SSB MESSAGE

Values: String

Default:

1.14.193 QSO BEFORE CW MESSAGE

Values: String

Default:

1.14.194 QSO BEFORE MESSAGE

Values: String

Default:

1.14.195 QSO BEFORE SSB MESSAGE

Values: String

Default:

1.14.196 QSO BY BAND

Values: TRUE or FALSE

Default: FALSE

These parameters determine whether QSOs can be counted again if they occur on different bands or modes. The parameters are set up automatically when the CONTEST statement in your *.CFG file is executed, and normally do not require any changes.

1.14.197 QSO BY MODE

Values: TRUE or FALSE

Default: FALSE

These parameters determine whether QSOs can be counted again if they occur on different bands or modes. The parameters are set up automatically when the CONTEST statement in your *.CFG file is executed, and normally do not require any changes.

1.14.198 QSO NUMBER BY BAND

Values: TRUE or FALSE

Default: FALSE

When set to TRUE, the QSO numbers that are displayed on the screen, those that are sent in a CW message with the # character, and those shown in the log will be calculated from the total number of contacts on the active band. This is useful in a multi-transmitter situation where QSO numbers are being sent (e.g., the CQ WPX contest).

1.14.199 QSO POINT METHOD

Values: *(NONE, ALL ASIAN, ARCI, ARI, ARRL FD, ARRL 160, ARRL 10, ARRL DX, ARRL VHF, ARRL VHF SS, BALTIC, CIS, CQ 160, CQ M, CQ VHF, CQ WW, CQ WW RTTY, CQ WPX, CQ WPX RTTY, CROATIAN, EUROPEAN FIELD DAY, EUROPEAN SPRINT, EUROPEAN VHF, FISTS, HA DX, HELVETIA, IARU, INTERNET SIX, IOTA, JA INTERNATIONAL DX, KCJ, LQP, NZ FIELD DAY, OK DX, RAEM, RAC CANADA WINTER, RSGB, RUSSIAN DX, RDA, SALMON RUN, SCANDINAVIAN, SOUTH AMERICAN, SOUTH AMERICAN WW, SL FIVE POINT, STEW PERRY, TEN TEN, TOEC, UBA, UKRAINIAN, VK ZL, WAE, WAG, WWL, YO DX, ALWAYS ONE, ONE POINT PER QSO, TWO POINTS PER QSO, THREE POINTS PER QSO, TWO PHONE FOUR CW, ONE PHONE TWO CW, THREE PHONE FIVE CW, TWO PHONE THREE CW, TEN POINTS PER QSO, ONE EUROPE TWO OTHER, RF CUP, R4W, RF CHAMP, UKR CHAMP, RADIO VHF FD, LZ, ONY, RF AS CHAMP, SRR JR, YU, REG 1 RCC, GACWWWSA, WW PMC, JT, RADIO 160, ARKTIKA-SPRING, GAGARIN-CUP, UN DX, KING OF SPAIN, WRTC, R9W-UW9WK-MEMORIAL, TAC, REF, RADIO-MEMORY, BSCI, MMAA, OZHCR-VHF, MAKROTHEN)*

Default: NONE

1.14.200 QSO POINTS DOMESTIC CW

Values: Integer (0 - 65535)

Default: -1

These parameters allow you to control the QSO point values for the class of QSOs indicated. These will over-ride any existing QSO point method for the contacts in the category indicated.

1.14.201 QSO POINTS DOMESTIC PHONE

Values: Integer (0 - 65535)

Default: -1

These parameters allow you to control the QSO point values for the class of QSOs indicated. These will over-ride any existing QSO point method for the contacts in the category indicated.

1.14.202 QSO POINTS DX CW

Values: Integer (0 - 65535)

Default: -1

These parameters allow you to control the QSO point values for the class of QSOs indicated. These will over-ride any existing QSO point method for the contacts in the category indicated.

1.14.203 QSO POINTS DX PHONE

Values: Integer (0 - 65535)

Default: -1

These parameters allow you to control the QSO point values for the class of QSOs indicated. These will over-ride any existing QSO point method for the contacts in the category indicated.

1.14.204 QSX ENABLE

Values: TRUE or FALSE

Default: TRUE

This parameter determines whether QSX information is decoded from packet spots. You might want to disable this feature if you are a DX station and are not interested in split spots.

1.14.205 QTC ENABLE

Values: TRUE or FALSE

Default: FALSE

This is normally turned on automatically when a WAE is being configured. When you have enabled QTCs, you will need to remember that ctrl-Q is the magic key to send (if you are not in EU) or receive (if you are in EU) QTCs. TR4W will automatically ensure that you do not send a QTC containing the call of the station to whom you are sending the QTC. On CW, both the ctrl-Enter and alt-K keys work as usual even when QTCs are being sent.

1.14.206 QTC EXTRA SPACE

Values: TRUE or FALSE

Default: TRUE

When this parameter is TRUE, extra spaces are inserted between the elements of a QTC.

1.14.207 QTC MINUTES

Values: TRUE or FALSE

Default: FALSE

When this parameter is TRUE, the QTC function will send only the minutes of QTC times that are in the same hour as the time previously sent.

1.14.208 QTC QRS

Values: TRUE or FALSE

Default: TRUE

When this parameter is TRUE, TR4W will send QTCs with the CW speed approximately 6% slower than the normal sending speed.

1.14.209 QUESTION MARK CHAR

Values: Char

Default: ?

Values: Any key. Some keyboards require the use of a shift key to type the question mark. This command can be used to assign the ? key to another key². This allows ²The author finds it useful to assign the = character with this command. operation without pressing the shift key, which may be inconvenient, or may change the rig frequency if your rig is interfaced to the computer.

1.14.210 QUICK QSL CW MESSAGE

Values: String

Default:

1.14.211 QUICK QSL CW MESSAGE1

Values: String

Default:

1.14.212 QUICK QSL KEY 1

Values: Char

Default:

1.14.213 QUICK QSL KEY 2

Values: Char

Default: =

Values: Any key. When you finish a contact while running on CW, normally you press to log the contact and send the QSL MESSAGE. If you want to send the QUICK QSL MESSAGE 2 instead, you press the QUICK QSL KEY2 instead of .

1.14.214 QUICK QSL MESSAGE 1

Values: String

Default:

1.14.215 QUICK QSL MESSAGE 2

Values: String

Default:

1.14.216 QUICK QSL SSB MESSAGE

Values: String

Default:

1.14.217 QZB RANDOM OFFSET ENABLE

Values: TRUE or FALSE

Default: FALSE

1.14.218 R150S MODE

Values: TRUE or FALSE

Default: FALSE

If TRUE calculation of contriyes-multipliers will be based on R-150-S list.

1.14.219 RADIO ONE BAND OUTPUT PORT

Values: 1, 2, 3 or NONE

Default: NONE

1.14.220 RADIO ONE BAUD RATE

Values: Integer - 1200, 2400, 4800, 9600, 19200, 38400, 57600, 115200

Default: 0

This command controls the baud rate between the computer and the connected rigs.

1.14.221 RADIO ONE CAT DTR

Values: (NONE, OFF, ON, CW, PTT)

Default: OFF

1.14.222 RADIO ONE CAT RTS

Values: (NONE, OFF, ON, CW, PTT)

Default: OFF

1.14.223 RADIO ONE CONTROL PORT

Values: (NONE, SERIAL 1, SERIAL 2, SERIAL 3, SERIAL 4, SERIAL 5, SERIAL 6, SERIAL 7, SERIAL 8, SERIAL 9, SERIAL 10, SERIAL 11, SERIAL 12, SERIAL 13, SERIAL 14, SERIAL 15, SERIAL 16, SERIAL 17, SERIAL 18, SERIAL 19, SERIAL 20, PARALLEL 1, PARALLEL 2, PARALLEL 3)

Default: NONE

Use these commands to specify the serial port to use for each connected rig.

1.14.224 RADIO ONE FREQUENCY ADDER

Values: Integer (0 - 65535)

Default: 0

1.14.225 RADIO ONE FT1000MP CW REVERSE

Values: TRUE or FALSE

Default: FALSE

If you have connected a Yaesu FT100, FT817, FT847, FT857, FT897, FT920 or FT1000MP to the computer, this parameter determines whether the rig uses normal or reverse mode for CW. FALSE=CW, TRUE = CW(R).

1.14.226 RADIO ONE ICOM FILTER BYTE

Values: Integer - 0, 1, 2, 3

Default: 2

Set width of the rig's filter. 0 - disable filter width control; 1,2,3 - Wide, Normal, Narrow filters. Applicable only for ICOM's rigs.

1.14.227 RADIO ONE KEYER DTR

Values: (NONE, OFF, ON, CW, PTT)

Default: CW

1.14.228 RADIO ONE KEYER RTS

Values: (NONE, OFF, ON, CW, PTT)

Default: PTT

1.14.229 RADIO ONE NAME

Values: String

Default: Radio 1

Values: Any text string.

1.14.230 RADIO ONE RECEIVER ADDRESS

Values: Integer (0 - 65535)

Default: 0

Values: Any integer (base 10). These two commands allow you to specify the receiver address when connecting to an Icom or Ten-Tec rig. The rig will have a specific receiver address that TR4W needs to know in order to communicate with it. The number must be entered in base 10.

1.14.231 RADIO ONE TYPE

Values: (NONE, K2, K3, TS850, FT100, FT450, FT736R, FT747GX, FT767, FT817, FT840, FT847, FT857, FT890, FT897, FT900, FT920, FT950, FT990, FT1000, FT1000MP, FT2000, FTDX9000, IC78, IC706, IC706II, IC706IIG, IC707, IC718, IC725, IC726, IC728, IC729, IC735, IC736, IC737, IC738, IC746, IC746PRO, IC756, IC756PRO, IC756PROII, IC756PROIII, IC761, IC765, IC775, IC781, IC910H, IC970D, IC7000, IC7200, IC7600, IC7700, IC7800, OMNI6, ORION)

Default: NONE

Type of radio one you have connected.

1.14.232 RADIO ONE WIDE CW FILTER

Values: TRUE or FALSE

Default: FALSE

Set width of CW filter. Actual for FT747GX, FT840, FT890, FT900, FT990, FT1000 rigs.

1.14.233 RADIO TWO BAND OUTPUT PORT

Values: 1, 2, 3 or NONE

Default: NONE

1.14.234 RADIO TWO BAUD RATE

Values: Integer - 1200, 2400, 4800, 9600, 19200, 38400, 57600, 115200

Default: 0

This command controls the baud rate between the computer and the connected rigs.

1.14.235 RADIO TWO CAT DTR

Values: (NONE, OFF, ON, CW, PTT)

Default: OFF

1.14.236 RADIO TWO CAT RTS

Values: (NONE, OFF, ON, CW, PTT)

Default: OFF

1.14.237 RADIO TWO CONTROL PORT

Values: (NONE, SERIAL 1, SERIAL 2, SERIAL 3, SERIAL 4, SERIAL 5, SERIAL 6, SERIAL 7, SERIAL 8, SERIAL 9, SERIAL 10, SERIAL 11, SERIAL 12, SERIAL 13, SERIAL 14, SERIAL 15, SERIAL 16, SERIAL 17, SERIAL 18, SERIAL 19, SERIAL 20, PARALLEL 1, PARALLEL 2, PARALLEL 3)

Default: NONE

Use these commands to specify the serial port to use for each connected rig.

1.14.238 RADIO TWO FREQUENCY ADDER

Values: Integer (0 - 65535)

Default: 0

1.14.239 RADIO TWO FT1000MP CW REVERSE

Values: TRUE or FALSE

Default: FALSE

If you have connected a Yaesu FT100, FT817, FT847, FT857, FT897, FT920 or FT1000MP to the computer, this parameter determines whether the rig uses normal or reverse mode for CW. FALSE=CW, TRUE = CW(R).

1.14.240 RADIO TWO ICOM FILTER BYTE

Values: Integer - 0, 1, 2, 3

Default: 2

Set width of the rig's filter. 0 - disable filter width control; 1,2,3 - Wide, Normal, Narrow filters. Applicable only for ICOM's rigs.

1.14.241 RADIO TWO KEYS DTR

Values: (NONE, OFF, ON, CW, PTT)

Default: CW

1.14.242 RADIO TWO KEYS RTS

Values: (NONE, OFF, ON, CW, PTT)

Default: PTT

1.14.243 RADIO TWO NAME

Values: String

Default: Radio 2

Values: Any text string.

1.14.244 RADIO TWO RECEIVER ADDRESS

Values: Integer (0 - 65535)

Default: 0

Values: Any integer (base 10). These two commands allow you to specify the receiver address when connecting to an Icom or Ten-Tec rig. The rig will have a specific receiver address that TR4W needs to know in order to communicate with it. The number must be entered in base 10.

1.14.245 RADIO TWO TYPE

Values: (NONE, K2, K3, TS850, FT100, FT450, FT736R, FT747GX, FT767, FT817, FT840, FT847, FT857, FT890, FT897, FT900, FT920, FT950, FT990, FT1000, FT1000MP, FT2000, FTDX9000, IC78, IC706, IC706II, IC706IIG, IC707, IC718, IC725, IC726, IC728, IC729, IC735, IC736, IC737, IC738, IC746, IC746PRO, IC756, IC756PRO, IC756PROII, IC756PROIII, IC761, IC765, IC775, IC781, IC910H, IC970D, IC7000, IC7200, IC7600, IC7700, IC7800, OMNI6, ORION)

Default: NONE

Type of radio two you have connected.

1.14.246 RADIO TWO WIDE CW FILTER

Values: TRUE or FALSE

Default: FALSE

Set width of CW filter. Actual for FT747GX, FT840, FT890, FT900, FT990, FT1000 rigs.

1.14.247 RADIUS OF EARTH

Values: Any number

Default: 0.00

This parameter can be used to override the internal value of the Earth's radius that is used for distance calculations. Enter the new radius in kilometers. A value of 0 causes TR4W to use the default internal value (which is 6378.1370 km).

1.14.248 RANDOM CQ MODE

Values: TRUE or FALSE

Default: FALSE

When this parameter is TRUE, the Auto-CQ function will behave differently when selecting CQ MEMORY F1. Instead of always playing the message recorded in F1, the Auto-CQ procedure will randomly pick CQs from memories F1 through F4. This allows you to sound like you are awake. Blank messages in F1 through F4 are ignored.

1.14.249 RATE DISPLAY

Values: (QSOS, QSO POINTS, BAND QSOS)

Default: QSOS

Values: QSOS or QSO POINTS. The rate display can show either the rate at which you are

making QSOs, or the rate at which your QSO points are increasing.

1.14.250 RELAY CONTROL PORT

Values: 1, 2, 3 or NONE

Default: NONE

1.14.251 REMAINING MULT DISPLAY MODE

Values: (NONE, ERASE, HILIGHT)

Default: HILIGHT

Values: NONE, ERASE, HILIGHT. This command allows you to control how the remaining multiplier display function will work. If it is set to NONE, there will not be any display of remaining multipliers. If set to ERASE, the multipliers will be removed from the list as they are worked. If set to HILIGHT, multipliers that you have not worked yet will be highlighted.

1.14.252 REMINDER

Default:

Reminders are messages that are programmed to be displayed at certain times or when certain events occur.

1.14.253 REPEAT S& P CW EXCHANGE

Values: String

Default:

1.14.254 REPEAT S&P EXCHANGE

Values: String

Default:

1.14.255 REPEAT S&P SSB EXCHANGE

Values: String

Default:

1.14.256 ROTATOR PORT

Values: (NONE, SERIAL 1, SERIAL 2, SERIAL 3, SERIAL 4, SERIAL 5, SERIAL 6, SERIAL 7, SERIAL 8, SERIAL 9, SERIAL 10, SERIAL 11, SERIAL 12, SERIAL 13, SERIAL 14, SERIAL 15, SERIAL 16, SERIAL 17, SERIAL 18, SERIAL 19, SERIAL 20, PARALLEL 1, PARALLEL 2, PARALLEL 3)

Default: NONE

Values: SERIAL 1 to SERIAL 6. This command is used to choose a serial port over which commands will be sent to the rotator control (which may be set with the ROTATOR TYPE command). To send the rotator to the direction for the country of a callsign in the Call Window, use the ctrl-P command.

1.14.257 ROTATOR TYPE

Values: (NONE, DCU1, ORION, YAESU, ALFA SPID)

Default: NONE

Values: DCU1, ORION or YAESU. Sets the type of the rotator control.

1.14.258 ROW COUNT

Values: Integer - 5, 6, 7, 8, 9, 10, 11, 12, 13, 14, 15

Default: 5

Number of log lines displayed in the main window.

1.14.259 S&P CW EXCHANGE

Values: String

Default:

1.14.260 S&P EXCHANGE

Values: String

Default:

1.14.261 S&P SSB EXCHANGE

Values: String

Default:

1.14.262 SAY HI ENABLE

Values: TRUE or FALSE

Default: FALSE

If you have programmed CW messages that include names from the TRMASTER database, SAY HI ENABLE will determine whether the names are actually used. This allows you to program the messages with the names included, but to disable them all without having to edit each message.

1.14.263 SAY HI RATE CUTOFF

Values: Integer (0 - 65535)

Default: 200

If SAY HI ENABLE is TRUE, TR4W will cease to greet the other station when your rate exceeds the value of SAY HI RATE CUTOFF.

1.14.264 SCORE POSTING URL

Values: URL

Default: <http://cqcontest.ru/postscore.jsp>

1.14.265 SCORE READING URL

Values: URL

Default: <http://cqcontest.ru>

1.14.266 SCP COUNTRY STRING

Values: String

Default: NONE

Values: Comma-separated list of country prefixes. This command allows you to limit the stations that are displayed by the Super Check Partial function. Entering a comma-separated list of country prefixes (e.g., K, VE, KL7, KH6, KP2, KP4) causes only stations from those countries to be displayed when performing the Super Check Partial function. The default is to list stations from all countries. If you place a ! or - in front of the list of countries, then only stations in countries not in the list will be displayed by Super Check Partial.

1.14.267 SCP MINIMUM LETTERS

Values: Integer - 0, 3, 4, 5

Default: 0

Values: 0, 3, 4, or 5. When this parameter is non-zero, it enables the automatic Super Check Partial function. When you enter the number of characters specified, partial calls will be automatically displayed. You must have a TRMASTER.DTA file available for the program for this feature to work.

1.14.268 SEND COMPLETE FOUR LETTER CALL

Values: TRUE or FALSE

Default: FALSE

The } character in a CW message will send the prefix or suffix of a corrected callsign. If you set this parameter to TRUE, it will send the complete callsign if it is only four characters in length.

1.14.269 SERIAL PORT DEBUG

Values: TRUE or FALSE

Default: FALSE

1.14.270 SERVER ADDRESS

Values: String

Default: LOCALHOST

The name or IP address of the computer that is running TR4WSERVER.

1.14.271 SERVER PASSWORD

Values: String

Default: TR4WSERVER

Value: 10 chars length string. Password for connection to TR4WSERVER.

1.14.272 SERVER PORT

Values: Integer (0 - 65535)

Default: 1061

Ethernet port number, which will used connection with TR4WSERVER.

1.14.273 SHIFT KEY ENABLE

Values: TRUE or FALSE

Default: TRUE

The shift keys can be used to adjust the RIT and frequency of Kenwood and some Yaesu rigs. To disable this feature, set this parameter to FALSE.

1.14.274 SHORT 0

Values: Char

Default: T

Values: Any character. Defines the character to be sent instead of a 0 in a QSO number if SHORT INTEGERS is TRUE.

1.14.275 SHORT 1

Values: Char

Default: A

Values: Any character. Defines the character to be sent instead of a 1 in a QSO number if SHORT INTEGERS is TRUE.

1.14.276 SHORT 2

Values: Char

Default: 2

Values: Any character. Defines the character to be sent instead of a 2 in a QSO number if SHORT INTEGERS is TRUE.

1.14.277 SHORT 9

Values: Char

Default: N

Values: Any character. Defines the character to be sent instead of a 9 in a QSO number if SHORT INTEGERS is TRUE.

1.14.278 SHORT INTEGERS

Values: TRUE or FALSE

Default: FALSE

When this parameter is TRUE, TR4W will allow short abbreviations for some integers when they are sent as part of a QSO number. The actual abbreviations that are used can be programmed using the Alt-P command or the SHORT 0, SHORT 1, SHORT 2, and SHORT 9 commands.

1.14.279 SHOW DOMESTIC MULTIPLIER NAME

Values: TRUE or FALSE

Default: FALSE

1.14.280 SHOW FREQUENCY IN LOG

Values: TRUE or FALSE

Default: TRUE

If the value is TRUE in Cabrillo log will substitute the actual frequency of QSO.

1.14.281 SHOW GRIDLINES

Values: TRUE or FALSE

Default: FALSE

1.14.282 SHOW TYPED CALLSIGN

Values: TRUE or FALSE

Default: TRUE

If TRUE typed callsign in callsign window will displayed in "Network" window.

1.14.283 SINGLE BAND SCORE

Values: (160, 80, 40, 20, 15, 10, 30, 17, 12, 6, 2, 222, 432, 902, 1GH, 2GH, 3GH, 5GH, 10G, 24G, LGT, All, NON)

Default: All

This command can be used to force the score calculator to use the QSOs for only a single band. If you change the value of the SINGLE BAND SCORE parameter during a contest, you will need to delete your *.RST file before restarting TR4W.

1.14.284 SINGLE RADIO MODE

Values: TRUE or FALSE

Default: FALSE

When this parameter is TRUE, TR4W will not switch rigs when you use the alt-R command.

1.14.285 SKIP ACTIVE BAND

Values: TRUE or FALSE

Default: FALSE

If you are using two rigs and SKIP ACTIVE BAND is TRUE, TR4W will skip over the band to which the other rig is tuned when switching bands using the alt-B or alt-V commands.

1.14.286 SLASH MARK CHAR

Values: Char

Default: /

Values: Any character. If you wish to use a different keyboard character to make the / mark, use this command to specify it. This is handy for some European keyboards.

1.14.287 SPACE BAR DUPE CHECK ENABLE

Values: TRUE or FALSE

Default: TRUE

Normally when you press when a callsign is present in the Call Window, TR4W will perform a dupe check on the displayed callsign. If you press without a callsign in the window, you will be put into S&P Mode and your callsign will be sent. If you set SPACE BAR DUPE CHECK ENABLE to FALSE, you will always go into S&P Mode and send your call, even if a call is present in the Call Window.

1.14.288 SPRINT QSY RULE

Values: TRUE or FALSE

Default: FALSE

If this parameter is TRUE, TR4W will automatically enter CQ Mode after completing a QSO in S&P Mode. This parameter is automatically set to TRUE when the Sprint contest is selected. See subsection 6.18.1 for more information on operating the Sprint. You should not set this variable to TRUE unless you are operating the Sprint. For similar (but not quite identical) behaviour in other contests, see the AUTO S&P ENABLE command.

1.14.289 START SENDING NOW KEY

Values: Char

Default: `^` (the open-single-quote key, not the apostrophe)

Values: Any key. If you are running stations on CW and a station that has answered you has already finished sending his call, but you have not yet finished typing his call, you can press the START SENDING NOW KEY. This will send the characters you have already typed, and also the ones that you type after hitting the key, until you press . After pressing , the normal exchange will be sent. You may set the START SENDING NOW KEY to the key with the command: START SENDING NOW KEY = SPACE If the cursor is in the Call Window, then the space bar only causes sending to begin if there is at least one character in the window.

1.14.290 STATIONS CALLSIGNS MASK

Values: String

Default: NONE

1.14.291 STEREO CONTROL PIN

Values: Integer - 5, 9

Default: 9

Values: 5 or 9. This command sets the number of the pin to be used for controlling stereo on the STEREO CONTROL PORT. If you use pin 5, then you cannot use the same port for controlling a DVK; if you use pin 9 then you cannot use the same port for band output.

1.14.292 STEREO CONTROL PORT

Values: 1, 2, 3 or NONE

Default: NONE

1.14.293 STEREO PIN HIGH

Values: TRUE or FALSE

Default: FALSE

This command sets the state of the STEREO CONTROL PIN on the STEREO CONTROL PORT. The value may be toggled with the function key command TOGGLESTEREOPIN.

1.14.294 SWAP PACKET SPOT RADIOS

Values: TRUE or FALSE

Default: FALSE

When this parameter is TRUE, TR4W reverses which rig receives a packet spot when ctrl-U and the left/right cursor keys are used. This is useful if your station is configured such that your rig number 2 is physically on the left.

1.14.295 SWAP PADDLES

Values: TRUE or FALSE

Default: FALSE

This parameter swaps the dit and dah inputs on the paddle port. This is handy if your paddle is wired backwards.

1.14.296 SWAP RADIO RELAY SENSE

Values: TRUE or FALSE

Default: FALSE

When this parameter is TRUE, TR4W reverses the polarity of the relay for controlling the radio.

1.14.297 TAIL END CW MESSAGE

Values: String

Default:

1.14.298 TAIL END KEY

Values: Char

Default:]

Values: Any key. The TAIL END KEY allows you to respond to tail enders when finishing a CQ mode QSO.

1.14.299 TAIL END MESSAGE

Values: String

Default:

1.14.300 TAIL END SSB MESSAGE

Values: String

Default:

1.14.301 TELNET SERVER

Values: String

Default: sk3w.se:8000

Address of default telnet cluster.

1.14.302 TEN MINUTE RULE

Values: (NONE, TIME OF FIRST QSO)

Default: NONE

Values: NONE or TIME OF FIRST QSO. This parameter selects the mode for the ten minute rule. The TIME OF FIRST QSO mode will cause the elapsed time since your first QSO on the active band to be displayed.

1.14.303 TUNE ALT-D ENABLE

Values: TRUE or FALSE

Default: FALSE

If this parameter is TRUE, then the following behaviour occurs: if you are in CQ Mode on the active radio, then as you tune the inactive radio, calls from the bandmap (if not dupes) are automatically entered so that they can be worked with the alt-D command. This saves you from having to enter the calls manually.

1.14.304 TUNE WITH DITS

Values: TRUE or FALSE

Default: FALSE

If this parameter is TRUE, TR4W sends a string of dits at 75 WPM when ctrl-Left-Shift is pressed

1.14.305 TWO RADIO MODE

Values: TRUE or FALSE

Default: FALSE

Values: TRUE or FALSE .When this parameter is TRUE, TR4W is in two radio mode. See section

1.14.306 UNKNOWN COUNTRY FILE ENABLE

Values: TRUE or FALSE

Default: FALSE

This parameter controls the generation of the unknown country file. This file will list all the QSOs with callsigns for which TR4W cannot determine the country. This is a good way to find calls that might be new multipliers for you. By default, the file is named UNKNOWN.CTY, but you can change the name of the file with the UNKNOWN COUNTRY FILE NAME command. You can also find unknown countries after the contest using the Multiplier Check procedure in POST.

1.14.307 UNKNOWN COUNTRY FILE NAME

Values: String

Default: UNKNOWN.CTY

Values: Any valid filename. TR4W will save log entries for QSOs with unknown countries to the named file if UNKNOWN COUNTRY FILE ENABLE is TRUE.

1.14.308 USE CONTROL PORT

Values: TRUE or FALSE

Default: FALSE

1.14.309 USE RECORDED SIGNS

Values: TRUE or FALSE

Default: FALSE

1.14.310 USER INFO SHOWN

Values: (NONE, NAME, QTH, CHECK SECTION, SECTION, OLD CALL, FOC NUMBER, GRID, CQ ZONE, ITU ZONE, USER 1, USER 2, USER 3, USER 4, USER 5, CUSTOM)

Default: NONE

The values correspond to fields in the TRMASTER database. Any one of these can be viewed in a window just below the Call Window for the station you are working. If you choose CUSTOM, your initial exchange will be built using the CUSTOM USER STRING. This allows you to choose multiple data fields and display them in any order.

1.14.311 VHF BAND ENABLE

Values: TRUE or FALSE

Default: FALSE

When set to TRUE, TR4W will allow the selection of the VHF and UHF bands using the alt-B and alt-V keys.

1.14.312 WAIT FOR STRENGTH

Values: TRUE or FALSE

Default: TRUE

When you use the [character in a CW message, TR4W will allow you to enter the strength of an RST report by pressing a single numeric key. If WAIT FOR STRENGTH is TRUE, the program will wait for you to enter the strength before continuing the CW message. If WAIT FOR STRENGTH is FALSE and you haven't pressed a key by the time the program is ready to send the strength, it will act as if you had pressed the 9 key and proceed with the message.

1.14.313 WAKE UP TIME OUT

Values: Integer (0 - 255)

Default: 0

TR4W can keep track of how many minutes have passed since your last QSO. If this number reaches a programmable limit, an alarm will sound once a minute until you work somebody. This is useful for long contests where you operate until brain death and need 20 or 30 minutes to become functional again. Since this is a dangerous time to try to set an alarm, the program will automatically start counting the minutes. The wake up time out alarm is disabled if the alarm has been set.

1.14.314 WARC BAND ENABLE

Values: TRUE or FALSE

Default: FALSE

This command allows you to operate on 30, 17 and 12 metres. The default is FALSE, unless you are in General QSO mode.

1.14.315 WEIGHT

Default: 1.00

Values: 0.5 to 1.5. This command controls the weight of the CW generated by the computer. For example, a value of 1.05 will add 5 percent to the duration of each dot and dash.

1.14.316 WILDCARD PARTIALS

Values: TRUE or FALSE

Default: TRUE

This command controls the working of the partial call function. When this parameter is FALSE, only calls that start with the input call will be shown. When set to TRUE (the default), the input call can appear anywhere within the partial call. This allows you to perform a partial call check with the prefix or the suffix, instead of only with the prefix. If your partial call function is working too slowly, you might try setting this flag to FALSE. This flag only affects the partial call display from the dupesheet. The super check partial display always will use wildcard partials.

1.14.317 WK AUTOSPACE

Values: TRUE or FALSE

Default: FALSE

If you pause for more than one dit time between a dit or dah Winkeyer2 will interpret this as a letter-space and will not send the next dit or dah until full letter-space time has been met.

1.14.318 WK CT SPACING

Values: TRUE or FALSE

Default: FALSE

Winkeyer2 supports contest spacing which reduces the wordspace time by one dit. Instead of 7 dits per wordspace, WK CT SPACING=TRUE selects six dits per wordspace.

1.14.319 WK DIT DAH RATIO

Values: Integer (33 - 66)

Default: 50

Modifies the ratio of dit time to dah time, the standard being 1:3 (dit:dah). The formula to determine dah/dit ratio is: $DAH/DIT = 3 * (nn/50)$. A value of 50 selects 1:3, a value of 33 would select 1:2, and a value of 66 would select 1:4.

1.14.320 WK ENABLE

Values: TRUE or FALSE

Default: FALSE

Use Winkeyer instead of internal program keyer.

1.14.321 WK FIRST EXTENSION

Values: Integer (0 - 250)

Default: 0

Value: integer in the range of (0 to 250) * 1 mSecs. Winkeyer2 addresses a problem often encountered when keying older transceivers that have a slow breakin response. Due to a slow receive to transmit changeover time, the first dit or dah of a letter sequence can be chopped and reduced in length. Adding a fixed amount to the first element of a sequence can compensate for this.

1.14.322 WK IGNORE SPEED POT

Values: TRUE or FALSE

Default: TRUE

If TRUE then TR4W will ignore change of Winkeyer speed spot position.

1.14.323 WK KEYER COMPENSATION

Values: Integer (0 - 250)

Default: 0

Value: integer in the range of (0 to 250) * 1 mSecs. Keying Compensation allows a fixed amount to be added to the length of all dits and dahs. QSK keying on modern transceivers can cause shortening of the dit and dah elements which is especially noticeable at high speeds. Winkeyer2 allows the length of the dit and dah elements to be increased uniformly to compensate for this. The adjustments are made in units of one-millisecond steps. The maximum adjustment is 250 mSecs. Key compensation is very similar to Weighting in that any adjustment added to the dits and dahs is subtracted from the spacing so the speed is not changed. The difference between weighting and compensation is that compensation is independent of speed, so if 10 msec of key compensation is selected 10 msec will be always be added regardless of speed.

1.14.324 WK KEYER MODE

Values: (*IAMBIC B, IAMBIC A, ULTIMATIC, BUG MODE*)

Default: IAMBIC B

In iambic mode Winkeyer2 makes both dits and dahs automatically based on which paddle you press. In bug mode Winkeyer2 makes the dits and you make the dahs. You also can use bug mode to operate in straight key mode or if you want to key through Winkeyer2 with a different keyer, simply set bug mode and use the dah input to key Winkeyer2. In either iambic mode, alternating dits and dahs are sent while both paddles are held closed. In mode B an extra alternate dit or dah is sent after both paddles are released. In Ultimatic mode when both paddles are pressed the keyer will send a continuous stream of whichever paddle was last pressed.

1.14.325 WK LEADIN TIME

Values: Integer (0 - 250)

Default: 0

Value: integer in the range of (0 to 250) * 10 mSecs. Time delay between when PTT is asserted and when CW keying will start.

1.14.326 WK PADDLE ONLY SIDETONE

Values: TRUE or FALSE

Default: FALSE

In WK2 you can choose to only use sidetone for paddle entry and mute it for CW sourced from the host port.

1.14.327 WK PADDLE SWAP

Values: TRUE or FALSE

Default: FALSE

Feature for right or left handed ops.

1.14.328 WK PADDLE SWITCHPOINT

Values: Integer (10 - 90)

Default: 50

Value: integer in the range of 10 - 90%. This controls when Winkeyer2 will start looking for a new paddle press after sensing the current one. If there is not enough delay the keyer will send unwanted dits or dahs, if there is too much delay it bogs you down because you can't get ahead of the keyer. The default value is one dit time (50) and is adjustable in percent of a dit time. The delay is calculated with this formula: $DELAY_TIME = (SWITCHPOINT * DIT_TIME) / 50$ where SWITCHPOINT is a value between 10 and 90.

1.14.329 WK PORT

Values: (NONE, SERIAL 1, SERIAL 2, SERIAL 3, SERIAL 4, SERIAL 5, SERIAL 6, SERIAL 7, SERIAL 8, SERIAL 9, SERIAL 10, SERIAL 11, SERIAL 12, SERIAL 13, SERIAL 14, SERIAL 15, SERIAL 16, SERIAL 17, SERIAL 18, SERIAL 19, SERIAL 20, PARALLEL 1, PARALLEL 2, PARALLEL 3)

Default: NONE

Serial port to which Winkeyer is connected.

1.14.330 WK SIDETONE FREQUENCY

Values: (4000, 2000, 1333, 1000, 800, 666, 571, 500, 444, 400)

Default: 800

Define one of the WK2 sidetone frequency. These frequencies are slightly different than WK1.

1.14.331 WK SIDETONE ENABLE

Values: TRUE or FALSE

Default: TRUE

Specifies whether Winkeyer sidetone is enabled.

1.14.332 WK TAIL TIME

Values: Integer (0 - 250)

Default: 0

Value: integer in the range of (0 to 250) * 10 mSecs. Define how long the transmitter will stay in transmit after keying has stopped.

1.14.333 WK WEIGHT

Values: Integer (10 - 90)

Default: 50

Value: integer in the range of 10 - 90%. This command allows a proportional amount to be either added or subtracted from the length of all dits and dahs sent. A value of 50 selects no weighting adjustment. Values less than 50 reduce weighting and values greater than 50 increase weighting. Note that weighting does not affect sending speed because any increase in keyed time is subtracted from spacing time. Reduction in weighting results in a thinner sounding keying while increased weighting results in a heavier sound. Since weighting tracks speed, a given weighting will sound the same at all speeds.

1.14.334 WINDOW SIZE

Values: Integer - 1, 2, 3, 4, 5, 6, 7, 8, 9, 10, 11, 12, 13, 14, 15

Default: 5

The relative ratio of 1 to 15, which determines the size of the main program window.

1.14.335 ZONE MULTIPLIER

Values: (*NONE, CQ ZONES, ITU ZONES, JA PREFECTURES, BRANCH ZONES, EU HFC YEAR, RF CHAMP ZONES*)

Default: NONE

This parameter tells TR4W how to handle the zone multipliers. It is normally set up by the CONTEST statement in your *.CFG file.

Preliminary

Preliminary